

FINAL REPORT

**USING HIGH-SPEED TEXTURE MEASUREMENTS TO IMPROVE
THE UNIFORMITY OF HOT-MIX ASPHALT**

Kevin K. McGhee, P.E.
Senior Research Scientist

Gerardo W. Flintsch, Ph.D., P.E.
Assistant Professor
Department of Civil and Environmental Engineering
Virginia Polytechnic Institute & State University

Edgar de León Izeppi
Graduate Research Assistant
Virginia Tech Transportation Institute

Virginia Transportation Research Council
(A Cooperative Organization Sponsored Jointly by the
Virginia Department of Transportation and
the University of Virginia)

In Cooperation with the U.S. Department of Transportation
Federal Highway Administration

Charlottesville, Virginia

May 2003
VTRC 03-R12

DISCLAIMER

The contents of this report reflect the views of the authors, who are responsible for the facts and the accuracy of the data presented herein. The contents do not necessarily reflect the official views or policies of the Virginia Department of Transportation, the Commonwealth Transportation Board, or the Federal Highway Administration. This report does not constitute a standard, specification, or regulation.

Copyright 2003 by the Commonwealth of Virginia.

ABSTRACT

This study introduces Virginia's efforts to apply high-speed texture measurement as a tool to improve the uniformity of hot-mix asphalt (HMA) pavements. Three approaches for detecting and quantifying HMA segregation through measuring pavement surface macrotexture were evaluated: (1) applying the methods proposed in NCHRP Report 441, which build on the ability to predict the expected "non-segregated" macrotexture; (2) using acceptance bands for texture similar to those used for HMA density; and (3) considering the standard deviation of the macrotexture as a measure of construction uniformity.

Based on the findings from a series of field tests, the researchers concluded that macrotexture measurement holds great promise as a tool to detect and quantify segregation for quality assurance purposes. None of the available equations for predicting non-segregated macrotexture (the approach in NCHRP Report 441) was found to work for all the construction projects evaluated. Additional information is necessary to establish target macrotexture levels. The acceptance bands approach produced reasonable results in most of the field-verification experiments, but it was significantly influenced by the actual variability within the section. An approach that used target levels of standard deviations was selected for further testing and implementation on a pilot basis.

FINAL REPORT

USING HIGH-SPEED TEXTURE MEASUREMENTS TO IMPROVE THE UNIFORMITY OF HOT-MIX ASPHALT

**Kevin K. McGhee, P.E.
Senior Research Scientist**

**Gerardo W. Flintsch, Ph.D., P.E.
Assistant Professor
Department of Civil and Environmental Engineering
Virginia Polytechnic Institute & State University**

**Edgar de León Izeppi
Graduate Research Assistant
Virginia Tech Transportation Institute**

INTRODUCTION

Segregation has long been a major problem in the production and placement of hot-mix asphalt (HMA). A segregated mix does not conform to the specifications for gradation and/or asphalt content in the original job-mix formula, creating a difference in the expected density and air void content of the mix. Research has shown that when this happens, the service life of the pavement decreases because of diminished stiffness, tensile strength, and fatigue life, resulting in accelerated pavement distresses such as raveling, longitudinal cracking, fatigue cracking, and rutting (Cross and Brown, 1993; Khedaywi and White, 1996). Recent research by Stroup-Gardiner and Brown (2000) published by the National Cooperative Highway Research Program (NCHRP) suggests that the agency costs for segregation range from 10% to as much as 50% of the original cost of the pavement. In Virginia, an average of 10% of the service life is lost because of low-level segregation, and this equates to a per-lane-mile loss of approximately \$3,000 (10% of 2 in, \$40/ton mix). Applied to the approximately 3,600 lane-miles of maintenance resurfacing (ignoring new construction) conducted each year, segregation could easily account for annual costs of as much as \$11 million.

Traditionally, segregated pavement is first identified through a highly subjective visual assessment. This too frequently results in disputes between contractors and highway agencies. Researchers (Cross and Brown, 1993; Ministry of Ontario, 1999) have attempted to develop reliable and independent methods to define, detect, and quantify segregation, but few have offered a feasible alternative to the initial visual inspection.

The study presented in NCHRP Report 441 (Stroup-Gardiner and Brown, 2000) investigated a variety of commonly available technologies for detecting segregation (visual identification, “sand patch” texture measurement, and nuclear density gauges) and measuring segregation (permeability, nuclear density/moisture content gauges, and destructive testing). Many developing technologies, such as infrared thermography, ground penetration radar, thin-lift

nuclear asphalt content/density gauges, dynamic (laser-based) surface texture measurement devices, and seismic pavement analyzers, were also evaluated. The criteria used to evaluate the methods and technologies included (1) the ability to measure and detect mixture properties that would change because of segregation and (2) the availability of equipment that could be used in a rapid, repeatable, and nondestructive manner, preferably at normal highway speed. The researchers recommended infrared thermography and dynamic texture measurements as the most promising technologies. The NCHRP 441 report further suggested that infrared thermography has good potential for quality control purposes because it can be used during paving operations. On the other hand, dynamically measuring texture appears to be the most practical means for detecting and quantifying segregation for quality assurance purposes.

Using Texture to Detect and Measure Segregation

The connection between HMA mix segregation and observable changes in surface texture was not just recently discovered. Earlier research at the University of Auburn (Cross and Brown, 1993) and the University of Kansas (Cross et al., 1997) identified this relationship. The significance of an objective measure of texture is likewise recognized through its presence in particular construction specifications (Ministry of Ontario, 1999). The significant advancement made by the work reported in NCHRP Report 441 (Stroup-Gardiner and Brown, 2000) involves the method used to measure texture. Although the earlier texture measurements were made using volumetric techniques specified by the American Society for Testing and Materials (ASTM) (e.g., the sand patch method; ASTM E-965 [ASTM, 2002]), this latest work applied high-speed laser-based equipment to collect semi-continuous measurements of pavement surface texture. The obvious advantages include the ability to take measurements at highway speeds and the ability to collect a practically continuous stream of texture estimates, a “texture profile,” and observe how it varies (or does not vary) along a pavement mat.

Measuring Texture Dynamically

Recently completed research in Virginia (McGhee and Flintsch, 2003) included an evaluation of two dynamic (or high-speed) texture measuring systems. The first of these was originally employed in the work by the National Center for Asphalt Technology (NCAT) that yielded NCHRP Report 441 (Stroup-Gardiner and Brown, 2000). Formerly known as the Federal Highway Administration’s (FHWA) ROSAN system (FHWA, 1997), the system is currently marketed as MGPS Surface. It uses a high-frequency laser sensor with a “footprint” selected specifically for delivering high-definition surface profiles. Among other capabilities, the MGPS system supplies texture estimates in terms of the ASTM E-1845 standard for mean profile depth (MPD) (ASTM, 2002).

The second system, fabricated by International Cybernetics Corporation (ICC) (McGhee and Flintsch, 2003), is included as part of the Virginia Transportation Research Council’s (VTRC) pavement evaluation vehicle. This system uses relatively slower sensors with a larger footprint (“profile-grade” lasers) and produces an estimate of texture using a root mean square (RMS) calculation on the filtered high-definition surface profile. Although this system is comparatively less sophisticated, early findings have shown it to be serviceable for most HMA

surfaces. In particular, McGhee and Flintsch (2003) found the ICC texture estimate to be useful for “positively” textured pavements (e.g., many dense-graded HMA mixes and chip seals) and very reliable for “neutrally” textured surfaces (e.g., some dense-graded HMA mixes, stone-matrix asphalt [SMA], and open-graded friction courses [OGFC]). The ICC system owned by the Virginia Department of Transportation (VDOT) does not (at this writing) provide a standard measure of MPD. Among the surfaces tested, however, it does appear to follow consistently the MPD at a value approximately 50% higher.

The ICC system does offer the advantage of being an integrated component of Virginia’s standard inertial profiling package. At this time, only the VTRC unit is equipped to measure and process texture data. However, should texture measurement become an “operational” issue, the macrotexture measurement capabilities would be relatively easy to activate for VDOT’s other inertial profilers.

Predicting “Non-Segregated” Texture

The most objective texture-based approach proposed in NCHRP Report 441 (Stroup-Gardiner and Brown, 2000) builds on the presumption that an “ideal” texture exists for every mix and that this ideal texture can be predicted using various properties of the original job-mix formula. Given this ideal as a target, actual texture measurements can be obtained and compared to the target to assess if and where, within a new surface, the mix has departed from the original formula. Through the use of a limited assortment of HMA mixes, a model for predicting ideal texture was developed; this model is referred to as the NCAT model in the current study. According to the NCHRP report, the non-segregated texture of an HMA surface could be computed based on Equation 1 ($R^2 = 0.65$):

$$ETD = 0.01980 * MAS - 0.004984 * P_{4.75} + 0.1038 * C_c + 0.004861 * C_u \quad [\text{Eq. 1}]$$

where

ETD = estimated mean texture depth (a function of MPD provided in ASTM E-1845 [ASTM 2002])

MAS = maximum size of the aggregate (mm)

$P_{4.75}$ = percentage passing the 4.75-mm sieve

C_c = coefficient of curvature = $(D_{30})^2 / (D_{10}D_{60})$

C_u = coefficient of uniformity = D_{60} / D_{10} (Note: The sign of C_u was changed from (-) to (+) after discussion with the authors; apparently, there was a typographical error in the report.)

D_{10} = the sieve size associated with 10% passing (mm)

D_{30} = the sieve size associated with 30% passing (mm)

D_{60} = the sieve size associated with 60% passing (mm).

Table 1 presents the average mix properties derived from field cores taken from various HMA mixes at the Virginia Smart Road in Blacksburg. The ETD values computed (with Eq. 1) using these measured mix properties are compared with corresponding average sand patch (MTD) measurements (ASTM E-965 [ASTM, 2002]) in Figure 1. The data in Figure 1 suggest that the equation yields a good estimate of the macrotexture for the finer mixes but cannot appropriately predict the macrotexture for the coarser SMA and OGFC mixes. No visual segregation was detected in any mix.

Table 1. Laboratory-Measured Properties of the Hot-Mix Asphalt Wearing Surface

Section	Mix	Binder	NMAS	MAS	P _b (%AC)	PP 9.5 (3/8 in)	PP 4.75 (No. 4)	PP 2.36 (No. 8)	PP 1.18 (No. 16)	PP 0.6 (No. 30)
A	SM-12.5D	PG 70-22	9.5	12.5	5.9	97.3	81.9	46.0	34.2	26.3
E-H	SM-9.5D	PG 70-22	9.5	12.5	5.9	93.8	61.6	41.4	29.2	20.1
J	SM-9.5D	PG 70-22	9.5	12.5	4.9	92.3	53.5	36.5	25.8	18.0
K	OGFC	PG 76-22	12.5	19	5.5	80.8	13.6	1.8	1.4	1.3
L	SMA-12.5D	PG 70-22	12.5	19	6.8	86.0	36.5	24.6	21.1	18.4

NMAS = nominal maximum aggregate size, MAS = maximum aggregate size, P_b = percent binder, AC = asphalt cement, PP No. = percent passing No.-mm sieve.

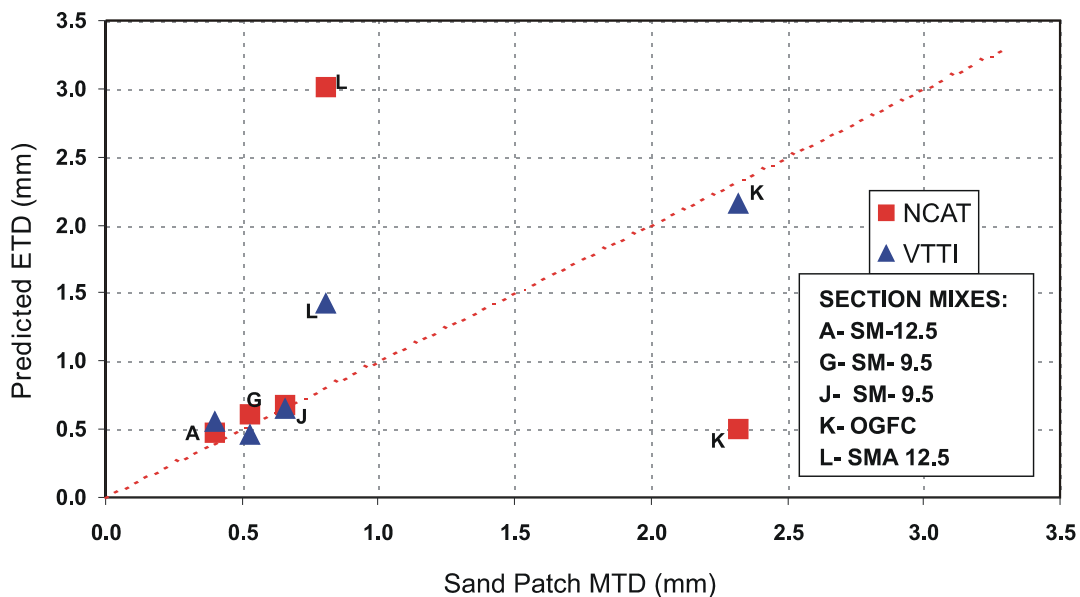

Figure 1. Measured versus Predicted Macrotexture. NCAT = model developed at the National Center for Asphalt Technology, VTTI = model developed at the Virginia Tech Transportation Institute, ETD = estimated mean texture depth (ASTM E-1845), MTD = mean texture depth (ASTM E-965).

Related work at the Virginia Tech Transportation Institute (VTTI) (Davis et al., 2002; Flintsch et al., 2003) investigated the possibility of predicting non-segregated field macrotexture based on mix properties determined from laboratory-compacted specimens. In this work, loose samples were collected during placement of the wearing surfaces of the Virginia Smart Road and specimens were prepared in the laboratory using VDOT mix design compaction procedures. Both VTTI studies reported that the surface macrotexture could be predicted using the nominal maximum aggregate size (NMAS) and voids in the mineral aggregate (VMA). The second study (Flintsch et al., 2003) provided the regression Equation 2 to compute an estimated texture (the VTTI model).

$$ICCTEX = -2.896 + 0.2993 * NMAS + 0.0698 * VMA \quad [Eq. 2]$$

where

ICCTEX = ICC estimated texture/profile depth (mm)

NMAS = nominal maximum aggregate size (mm)

VMA = voids in the mineral aggregate (%).

The model had an R^2 value of 0.965 and a root mean squared error (RMSE) of 0.123 mm. Figure 1 shows that this model predicts macrotexture values similar to those predicted by the NCAT model for the fine mixes but performed better for the nontraditional coarser SMA and OGFC mixes.

Problem Statement

NCHRP Report 441 (Stroup-Gardiner and Brown, 2000) presents an intriguing approach for detecting and measuring segregation in HMA pavements. However, any approach built on models that predict texture must be critically evaluated for use with Virginia's mixes. A preliminary analysis of mixes from Virginia's Smart Road suggested that the NCAT model might not relate well to particular mixes, and work at VTTI also indicated that simplification may be possible. In addition, the dynamic texture measuring technologies used operationally in Virginia are measurably different those used in the NCHRP 441 study.

PURPOSE AND SCOPE

The purpose of this research was to support the development of a mechanism to promote maximum uniformity in Virginia's HMA pavements. The objectives were to evaluate the need and ability to predict surface texture for non-segregated HMA, thereby establishing a target or ideal texture; confirm the adequacy of Virginia's operational texture-measuring equipment as a

tool to administer a special provision for HMA uniformity; and develop a tool to promote HMA uniformity.

Three alternatives were investigated to provide a framework for improving HMA uniformity:

1. Define expected non-segregated macrotexture for the surface of the pavement based on HMA volumetric properties, and define “segregation levels” using ratios of measured to predicted texture (i.e., the approach proposed in NCHRP Report 441 [Stroup-Gardiner and Brown, 2000]).
2. Use an “acceptance bands” approach in which the average and standard deviation for each section are computed and then used to identify areas of excessive variability that can be associated with non-uniformity, or segregation, of the surface.
3. Using descriptive statistics from selected field projects, set target values for expected standard deviations of texture and use them to define levels of expected uniformity.

METHODS

Following an extensive review of the relevant literature and current practice, the project moved into a series of field experiments designed to gather key information on segregation (or uniformity) of typical Virginia mixes. The ability to predict non-segregated texture as a basis for assessing segregation was examined using measured texture (dynamically and with a static reference) combined with the various mix properties determined from cores. The research then moved to a focus on variability in texture within the included field projects. This portion of the study explored two simpler approaches for assessing segregation by looking at acceptance bands for measured texture and then pure uniformity, which focuses on texture fluctuation.

A more complete discussion of pavement texture and texture measuring devices can be found elsewhere (Henry, 2000). For the purposes of this research, the terms *texture* and *macrotexture* are used interchangeably. Strictly speaking, the component of pavement surface texture that is most relevant to this subject is termed *macrotexture*.

Field Experiments

Test Site Selection and Setup

The foundation of this project was a series of field experiments designed to sample the uniformity of typical VDOT paving mixtures. In the selection of the test sites, an effort was made to represent typical mixes from across the state while targeting mixes with evidence of segregation. For surface mixes, the potential candidates were drawn primarily from VDOT’s

active maintenance resurfacing schedule. Several ongoing new construction projects provided candidates for intermediate and base mix testing.

Upon selection of a candidate project, the site was “scouted” with the VTRC pavement evaluation vehicle (Figure 2). A single test run with the dynamic texture system (set to the highest resolution) was conducted. Next, a report that provided texture estimates every 2 ft for the length of the project was generated and reviewed to identify areas where the texture was most pronounced or actively fluctuating. The research team then traveled to those locations to visually assess their suitability for further tests.



Figure 2. VTRC Pavement Evaluation Vehicle Collecting Dynamic Texture Data

Dynamic Macrotexture Measurements

Provided that the dynamic texture data and visual review suggested an identifiable non-uniformity in the mat, the lane(s) was closed (as required) and a test site was established. Figure 3 illustrates the layout of a typical test site. Since the dynamic texture data were available from only the left and center laser sensors of the pavement evaluation vehicle (see closeup of sensor configuration in Figure 3), corresponding static tests were confined to those locations. The entire test site was 120 ft in length (one site was 150 ft in length) and centered on the most pronounced (visually determined) area of non-uniformity. Once a test site was selected, the limits of the site were identified and traffic cones (outfitted with highly reflective striping) placed at each end. Before any further layout work was done, two further dynamic texture-measuring passes were made using an automatic triggering system (triggered by the tape on the cones) to ensure that any static measurements could be matched precisely with data from the dynamic equipment. The results from these two passes were averaged to provide the texture profile data for further analysis. Once this step was completed, the remainder of the layout and testing took place.

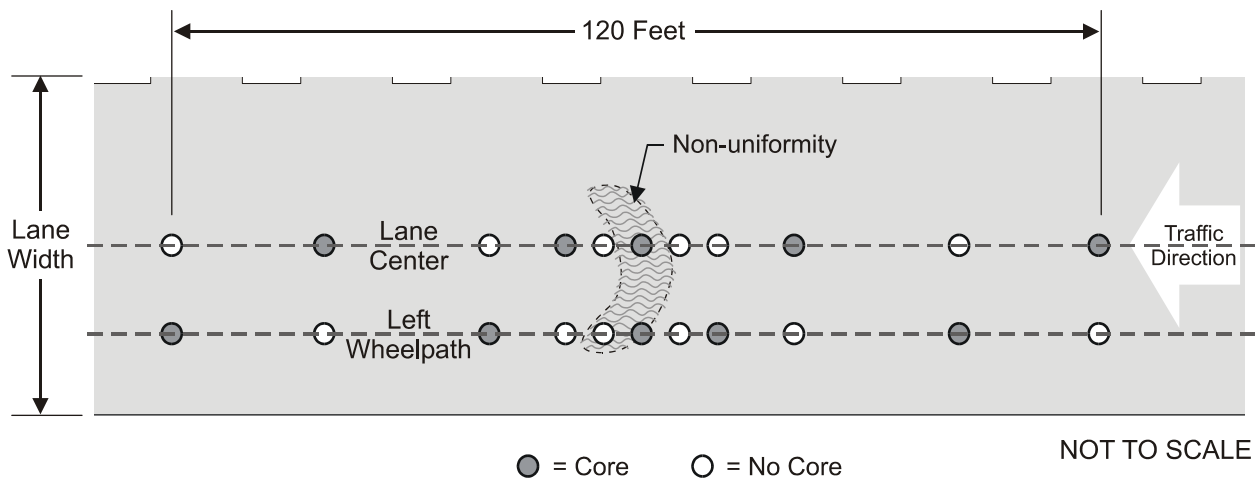
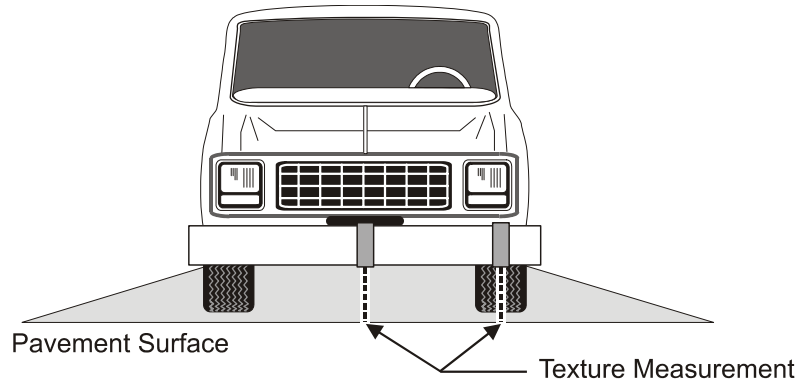

Figure 3. Test Site Layout. The circles depict locations where static tests were performed. At the center of the test site, the measurements were made at 5-ft intervals. After the first two series of tests, the spacing was expanded to 10 and then 20 ft. Following the completion of static tests, cores were taken at the locations indicated with shaded circles.

Static Tests

Upon the completion of dynamic testing and site layout, a series of non-destructive static tests was conducted, followed by the extraction of ten 6-in cores. Table 2 lists the non-destructive tests used and the corresponding American Association of State Highway and Transportation Officials (AASHTO), ASTM, or Virginia Test Method (VTM) designation when available. This series of static tests was performed at each location depicted by a circle in Figure 3 (one test per location). The Circular Track Texture Meter (CTM, Figure 4) is discussed elsewhere (Henry, 2002; McGhee and Flintsch, 2003; ASTM, 2002) but is essentially a modern surrogate for the volumetric (sand patch) texture measurement. The nuclear and electromagnetic pavement quality indicator (PQI) density measurements (Figure 5) were made to assess relative compaction levels throughout a test section. Since many of these test sections had been in place for several weeks (some with recent rains) and no attempt was made to calibrate the devices to known densities, the output reflected relative density only.

Table 2. Non-destructive Static Tests

Device	Measurement	Test Designation
Circular Track Texture Meter	Mean profile depth (MPD)	ASTM E-1845/E-2157
Nuclear gauge	Density (pcf)	VTM 76, VTM 81
PQI electromagnetic-based density meter	Density (pcf)	N/A; see PQI Manual
	Surface temperature (F)	
	Water content (%)	

PQI = Pavement Quality Indicator; PQI Manual = PQI Operator's Handbook (Transtech, 2002).



Figure 4. Circular Track Texture Meter (CTM)

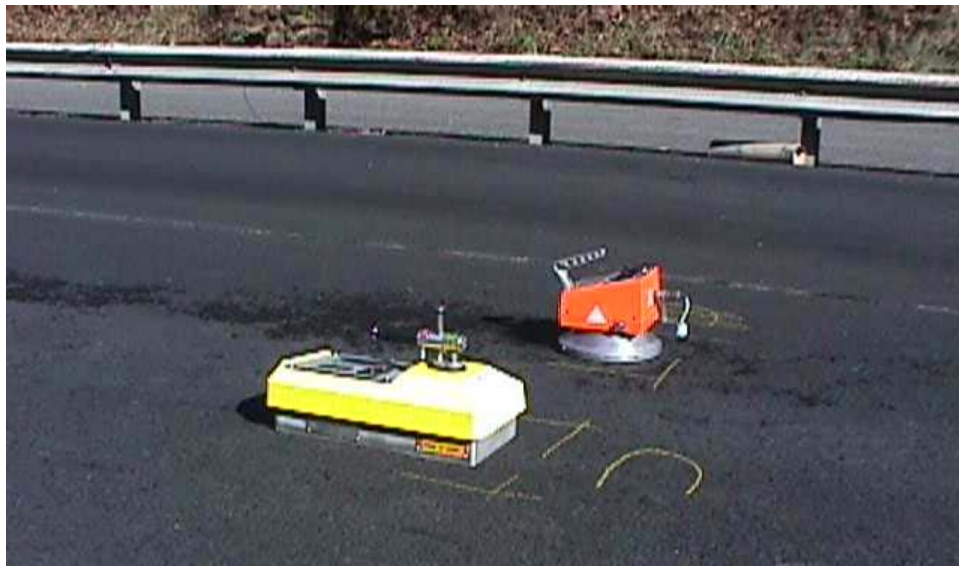

Figure 5. In Situ Density Measurements

The 10 cores were distributed in an attempt to measure as much of the as-built variability as possible (within a test section). It was important that data be gathered from both segregated and non-segregated areas (as determined by visual inspection). Table 3 lists the laboratory tests performed on the cores. As was the case with non-destructive field density measurements, the requirements of particular lab testing procedures were “compromised” to ensure the fullest characterization of mix properties throughout a test section. For example, a full gradation analysis requires a larger sample than was possible with a single 6-in core. Instead of combining material from several cores to comply with the AASHTO T 11 test procedures (AASHTO, 2002), the analyses were conducted with a smaller amount of separate material.

Table 3. Tests Conducted on Field Cores

Measurement	Test Designation
Core Height (mm)	
Specific Gravity, SSD	AASHTO T 166
Voids/Density (%)	AASHTO T 269
Lab Permeability (cm/sec)	VTM 120
AC Content	AASHTO T 308
Gradation Data	AASHTO T 11 and T 27

SSD = saturated surface dry, AC = asphalt cement.

Predicting Non-segregated/Target Pavement Surface Texture

The majority of each section was observed to be relatively uniform, and corresponding test results confirmed no measurable segregation. The mix properties for these non-segregated areas (derived from cores) were used to generate “target” ETD (NCAT model) and ICCTEX (VTTI model) values using the models depicted by Equations 1 and 2, respectively. Since the VTTI model had been developed using the texture data from the ICC system (ICCTEX), it was possible to input the dynamic texture directly. For the NCAT model, however, it was first necessary to convert the data to ETD based on the transfer functions given in Equations 3 and 4, which were developed in earlier work (Davis et al., 2002; Flintsch et al., 2003).

$$ETD = 0.78ICCTEX - 0.38 \quad [Eq. 3]$$

$$ETD = 0.98MPD_{CTM} + 0.04 \quad [Eq. 4]$$

where

ETD = estimate of *mean* texture depth

$ICCTEX$ = estimate of macrotexture as computed by a proprietary algorithm

MPD_{CTM} = MPD computed by the CTM.

Once the target texture values were calculated, it was possible to review the texture profiles for a test section to characterize estimated levels of segregation. This step applied the procedures presented in Appendix J of NCHRP Report 441 (Stroup-Gardiner and Brown, 2000) ,

which estimate the level of segregation by comparing measured texture and expected texture. The various degrees of segregation are determined using the ratios (of measured to expected macrotexture) as provided in Table 4.

Table 4. Factors for Estimating Levels of Segregation from Texture

Limit	No Segregation	Low-Level Segregation	Medium-Level Segregation	High-Level Segregation
Lower	0.75	1.16	1.57	>2.09
Upper	<1.15	1.56	2.09	None

Acceptance Bands

The acceptance bands approach to measuring segregation involved computing the average and standard deviations for each test section and using these statistics to establish limits that defined the outer boundaries of acceptable variation for the macrotexture. Acceptable bands are typically established by considering the mean plus or minus a particular factor times the standard deviation. In this research, 1 and 2 standard deviations were used. These values establish confidence intervals corresponding to levels of confidence of approximately 70% and 95%, respectively. This approach is similar to that recommended for evaluating the uniformity of a production run in Appendix H of the AASHTO *Implementation Manual for Quality Assurance* (AASHTO, 1996).

Standard Deviation–Based Uniformity

This option explored the potential for using empirically determined targets for surface texture variability (as distinguished from simply targets for surface texture). A tenet of this approach was that variability (standard deviation) of texture fluctuates proportionally (and consistently) with NMAAS. Further, if the variability of texture increases, it is assumed that the material/placement process was at least temporarily under less control (less uniform) and that the mat is consequently exhibiting at least some segregation. If reasonable targets for standard deviation of texture can be established for each mix *type* (not each mix), levels of desirable variability (incentive work) and deleterious variability (disincentive work) can be prescribed.

Using texture data from the eight test sections, a series of acceptance quality ranges was established using the following procedures:

1. Separate dynamic texture data according to NMAAS (i.e., group by mix type—9.5-mm mixes, 12.5-mm mixes, etc.).
2. Review texture profiles to identify zones in which the texture was particularly “well behaved” (better than average uniformity), where the texture varied normally (probably not segregated), and where the texture fluctuated dramatically (probably segregated, higher average texture values).

3. Extract the anticipated “pay lot” length (0.01-mi, or approximately 50 ft) of texture profile for each zone, and calculate the standard deviation of texture.
4. Align these proposed bands of variability with appropriate pay adjustments (see the recommendations in NCHRP Report 441 [Stroup-Gardiner and Brown, 2000] for disincentives/corrections).
5. Apply proposed acceptance quality criteria to actual data to assess the “reasonableness” of the outcome (i.e., simulated, or “shadow,” application).

FINDINGS

Field Tests

Table 5 presents location information for the eight field projects tested. Six of the projects were part of VDOT’s annual maintenance resurfacing program, and two of the test sections were new construction work. There were two test sites for every mix designation, with the exception of the 19-mm mixes for which one site was an intermediate mix and the other a surface mix. With each mix pairing, one of the sites was considered (subjectively at least) to be part of a typical-to-good project and the other was considered to be “non-uniform” (i.e., at least moderate segregation was observed).

Table 5. Field Tests Locations/Mix Types

Project	Location	County	District	Mix
02-1026 ^a	I-81 Southbound from Woodstock	Shenandoah	Staunton	BM-25
02-1039 ^a	Rt. 7 West of Leesburg	Loudoun	NOVA	SM-9.5
02-1041	Rt. 7 East of Berryville	Frederick	Staunton	SM-12.5
02-1043	Rt. 15 East of Gordonsville	Orange	Culpeper	SM-9.5
02-1050	Rt. 522 West of Rt. 3 in Culpeper	Culpeper	Culpeper	BM-25
02-1056	Rt. 29 North of Danville	Pittsylvania	Lynchburg	IM-19.0
02-1068 ^a	Rt. 33 West of Elkton	Rockingham	Staunton	SM-12.5
02-1079 ^a	Rt. 460 East of Cedar Bluff	Tazewell	Bristol	SM-19.0

^aAreas of segregated mix were evident.

Mix Characterization from Field Cores

The average mix characterization results for each site are presented in Table 6. Only the values obtained for the cores extracted from the *non-segregated* areas were included for computing the average results. Figure 6 shows an example of a non-segregated area and a segregated area for a 19-mm NMAS surface mix.

Table 6. Average Non-Segregated Mix Properties

Project	Mix	P _b (% AC)	MAS (mm)	NMAS (mm)	PP 4.75 (%)	C _c	C _u	VMA (%)	VTM (%)
02-1039	SM-9.5D	5.56	12.5	9.5	57	2.61	31.0	20.2	6.4
02-1043	SM-9.5	5.64	12.5	9.5	61	1.41	33.9	19.6	7.2
02-1041	SM-12.5	5.19	19.0	12.5	48	5.31	48.8	22.4	10.9
02-1068	SM-12.5A	6.05	19.0	12.5	54	2.23	31.8	21.5	9.8
02-1056	IM-19.0	5.35	25.0	19.0	51	1.52	33.1	19.0	7.5
02-1079	SM-19.0	4.80	25.0	19.0	57	3.48	48.0	13.6	5.3
02-1026	BM-25	4.97	37.5	25.0	39	3.78	47.7	19.4	8.0
02-1050	BM-25	4.72	37.5	25.0	43	2.37	56.6	17.0	6.1

P_b = percent binder , AC = asphalt cement, MAS = maximum aggregate size, NMAS = nominal maximum aggregate size, PP = percent passing , C_c = coefficient of curvature, C_u = coefficient of uniformity, VMA = voids in mineral aggregate, VTM = total voids in mix. Since the gradations were obtained from field cores, which do not provide enough material for the coarser mixes (BM-25 and IM-19), the MAS and NMAS obtained from the gradation analysis were modified to match the mix denomination.

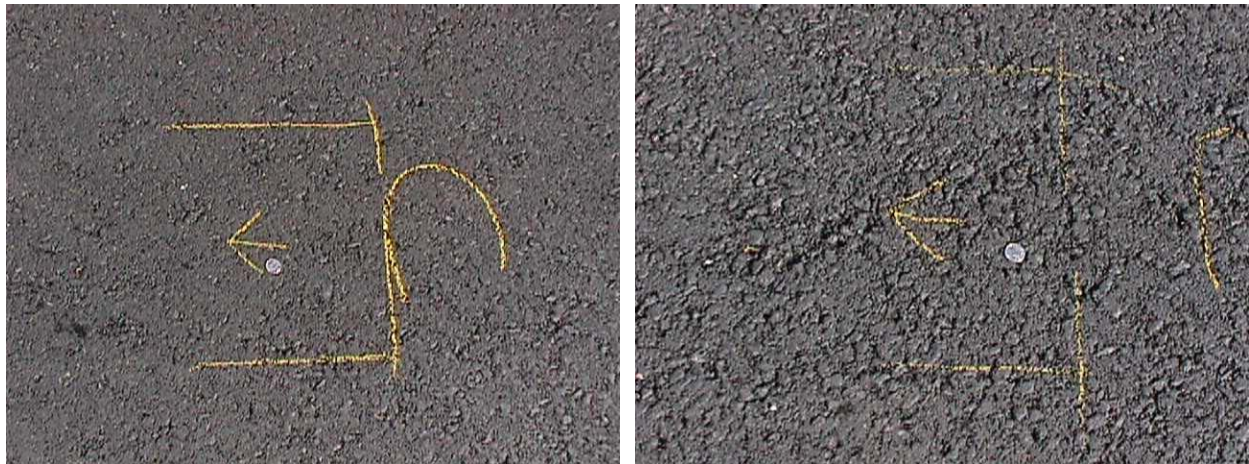

Figure 6. Examples of Non-segregated and Segregated Areas (SM-19.0, Tazewell)

Before the methods that use texture as a basis for estimating segregation are discussed, more traditional (destructive) methods for confirming mix segregation are reviewed. Table 7 provides additional measures from the test sections described in Table 6. Instead of reporting the “average” measured properties, Table 7 highlights extremes in measured voids (VTM) and binder content (P_b). The differences (delta %) between the average and extreme properties have been shown to correlate well with segregation (Stroup-Gardiner and Brown, 2000). Using ranges recommended in NCHRP Report 441 (Stroup-Gardiner and Brown, 2000), the table further reports the maximum degree of segregation within these test sections. Even among these destructive measures of segregation, complete agreement rarely exists. This disagreement may simply be due to sample and testing variability. It may also relate, however, to *temperature* segregation effects (explained in NCHRP Report 441 [Stroup-Gardiner and Brown, 2000]), which would explain low densities but acceptable binder content.

Table 7. Extreme Mix Properties and Corresponding Expected Levels of Segregation

Project	Mix	P _b (min %AC)	P _b (delta %)	Estimated Segregation Level	VTM (max %)	VTM (delta %)	Estimated Segregation Level
02-1039	SM-9.5D	5.38	-0.18	None	8.9	2.5	Low
02-1043	SM-9.5	4.9	-0.74	Low	12.6	5.4	High
02-1041	SM-12.5	5.04	-0.15	None	15.9	5.0	Medium/high
02-1068	SM-12.5A	4.38	-1.67	High	13.8	4.0	Low/med
02-1056	IM-19.0	4.77	-0.58	Low	9.9	2.4	Low
02-1079	SM-19.0	4.28	-0.52	Low	11.1	5.8	Medium/high
02-1026	BM-25	3.56	-1.41	High	9.9	1.9	None/low
02-1050	BM-25	4.37	-0.35	Low	7.8	1.7	None/low

P_b = percent binder, VTM = total voids in mix

Non-Destructive/Macrotexture Measurements

Generally, the results from the non-destructive field tests were very encouraging, since in most cases the visibly segregated areas corresponded well with peaks in the measured macrotexture. This trend was evident with the data from both the CTM and the dynamic equipment. Figure 7 shows measurements obtained on the test section on I-81 near Woodstock, which was badly segregated at the center of the section. The area of reduced density (segregated) shows the highest macrotexture values. In contrast, Figure 8 presents another example for a BM-25 mix that was not visibly segregated. In this case, the texture is considerably more uniform and the nuclear density measurements are similarly stable.

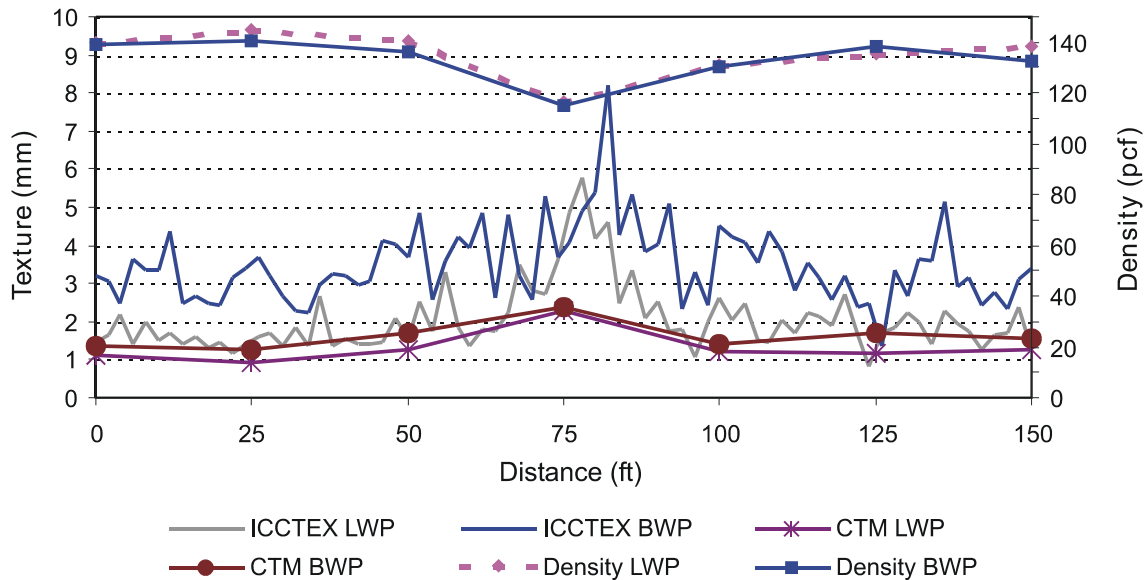

Figure 7. Test Site with Pronounced Segregation (Project 02-1026). ICCTEX = texture estimate from ICC system; ICCTEX LWP = ICCTEX for left wheelpath; ICCTEX BWP = ICCTEX for lane center (between wheelpaths); CTM = circular track texture meter; CTM LWP = CTM-based mean profile depth (MPD) for LWP (left wheelpath); CTM BWP = MPD for lane center; Density LWP = nuclear density reading for left wheelpath; Density BWP = nuclear density reading for lane center.

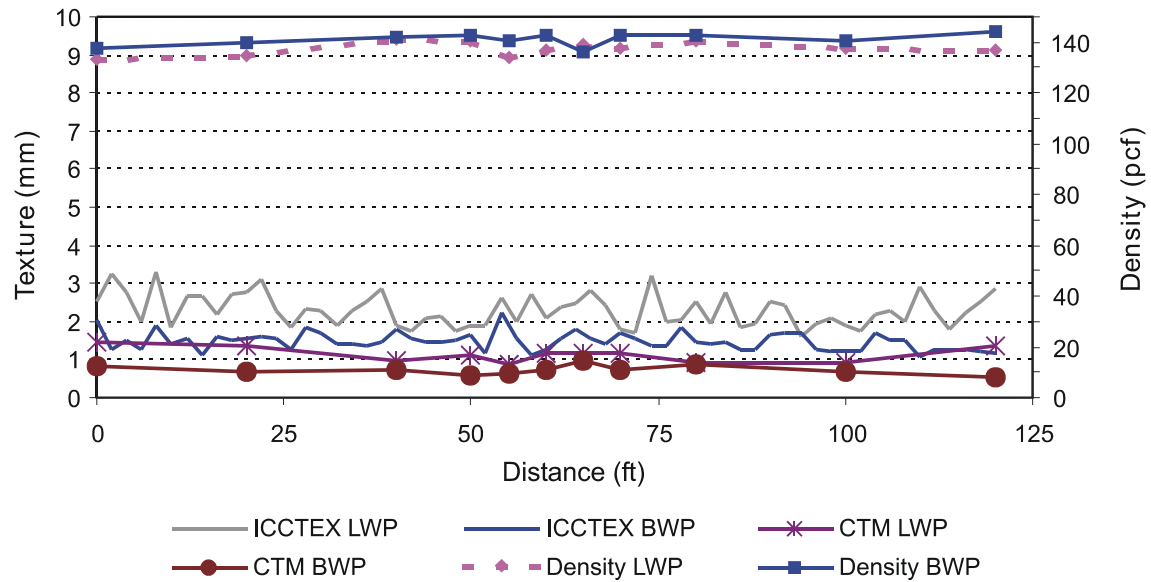

Figure 8. Test Site Without Pronounced Segregation (Project 02-1050). ICCTEX = texture estimate from ICC system; ICCTEX LWP = ICCTEX for left wheelpath; ICCTEX BWP = ICCTEX for lane center (between wheelpaths); CTM = circular track texture meter; CTM LWP = CTM-based mean profile depth (MPD) for LWP (left wheelpath); CTM BWP = MPD for lane center; Density LWP = nuclear density reading for left wheelpath; Density BWP = nuclear density reading for lane center.

Predicting Texture

Figures 9 through 11 illustrate the various measures of texture (including conversion as necessary) for one of the test sites. Plotted with the texture measurements are the estimated ranges of texture that define segregation according to the ratios provided in Table 4. In Figure 9, the estimated target texture was generated using the VTTI model (Eq. 2). For Figures 10 and 11, the estimated values came from the NCAT model (Eq. 1) and were translated through either the ICCTEX or the CTM MPD data. Although the figures represent the same test section, the estimated levels of segregation differ considerably.

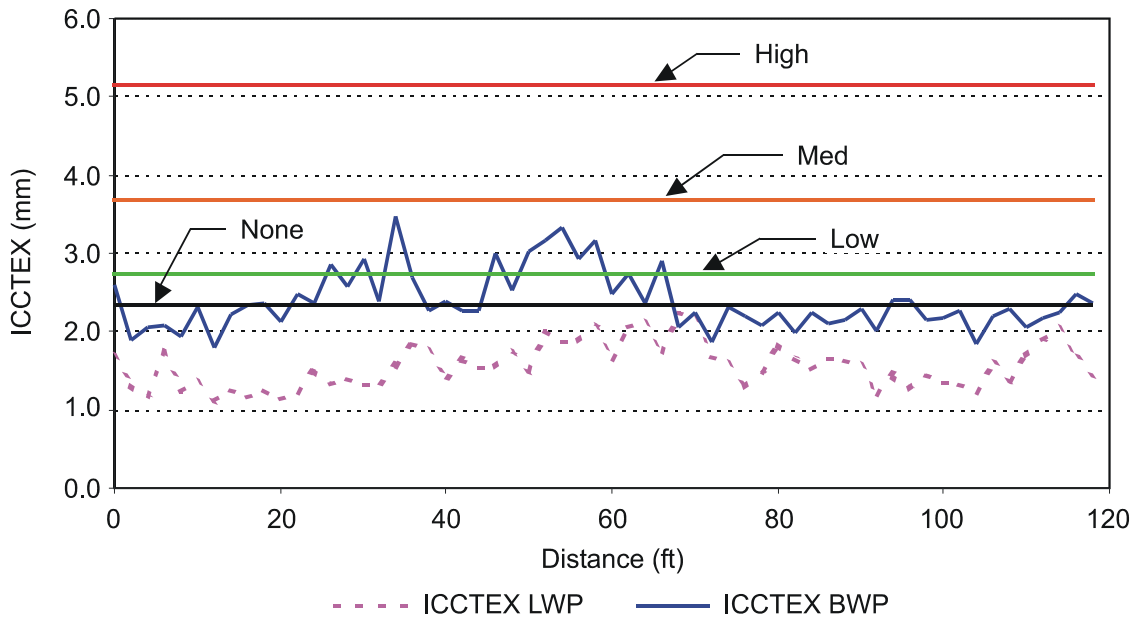

Figure 9. Example Segregation Analysis Using VTTI Model (Project 02-1068). ICCTEX = texture estimate from ICC system; ICCTEX LWP = ICCTEX for left wheelpath; ICCTEX BWP = ICCTEX for lane center (between wheelpaths).

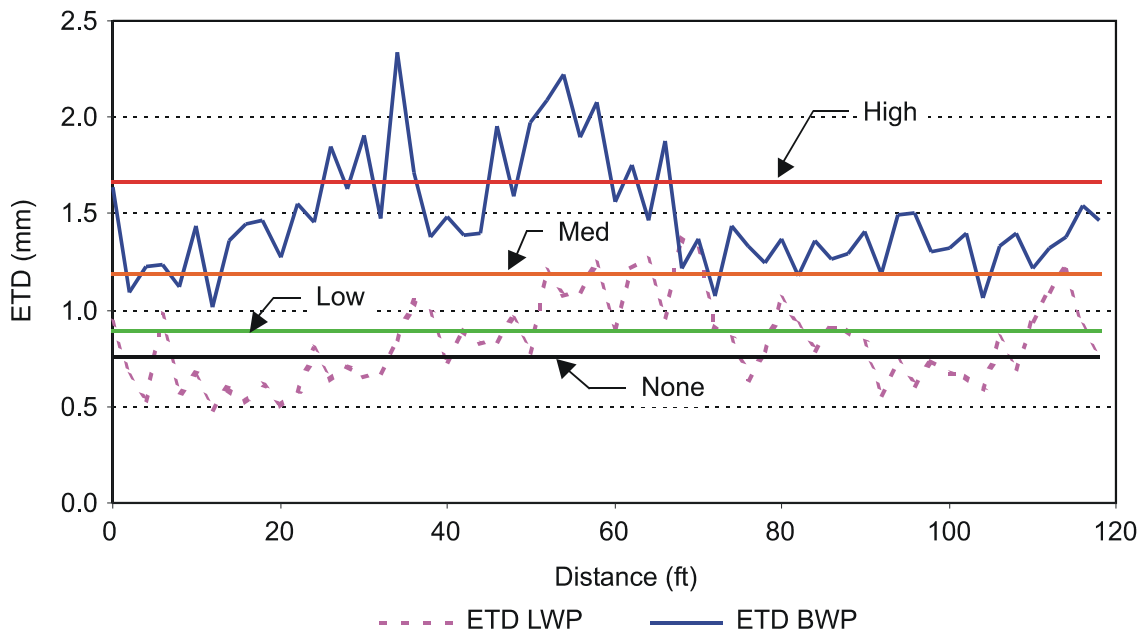

Figure 10. Example Segregation Analysis Using NCAT Model with Converted ICCTEX Data (Project 02-1068). ICCTEX = texture estimate from ICC system, ETD = estimated texture depth, ETD LWP = ETD for left wheelpath, ETD BWP = ETD for lane center (between wheelpaths).

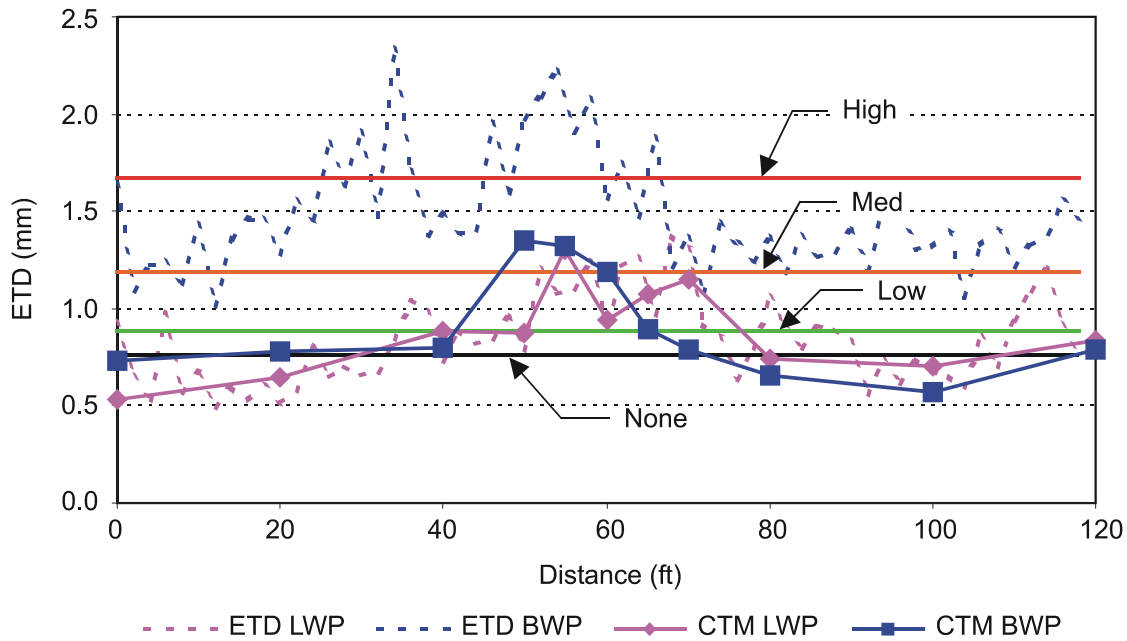

Figure 11. Example Segregation Analysis Using NCAT Model With Converted CTM Data (Project 02-1068). CTM = circular track texture meter, ETD = estimated texture depth, ETD LWP = ETD for left wheelpath, ETD BWP = ETD for lane center (between wheelpaths), CTM LWP = CTM-based ETD for left wheelpath, CTM BWP = CTM-based ETD for lane center (between wheelpaths).

Table 8 summarizes the application of the target texture approach to all eight test sections. It reports the percentage of each section that exhibited various levels of segregation. The results are organized by the transverse location (left wheelpath [LWP] or lane center [BWP]), texture model used, and texture-measuring device. Although both models produce reasonable results in most cases, they both tend to overestimate the segregated areas for at least some of the projects studied. For example, in Project 02-1026 (represented in Figure 7) most of the BWP (71%) and part of the LWP (14%) are segregated based on the CTM measurements and the NCAT model. However, only the central part of the project was visually segregated. On the other hand, the VTTI model (for this project) predicted such high expected texture values that it failed to detect any significant segregation.

Acceptance Bands

The bands for 1 and 2 standard deviations for LWP measurements on Project 02-1026 are presented in Figure 12. A relatively small segregated area was detected, showing that this approach could also work to detect localized segregation. However, it may not be appropriate to measure overall construction quality since the texture for a section may have a uniformly high variability (and standard deviation). This would hide the segregated areas because the acceptance bands would be very wide. Further, when the texture for a section has a very low standard deviation, a small spike in macrotexture would be mistakenly marked as a segregated spot, as is the case in Figure 13.

Table 8. Segregation Level Distribution (%) According to Target Texture Approach

Mix	Project	Segregation Level	LWP			BWP		
			VTTI	NCHRP 441		VTTI	NCHRP 441	
				ICC	CTM		ICC	CTM
SM-9.5	02-1039 ^a	None	77	73	0	42	33	0
		Low	13	13	9	52	40	27
		Medium	10	13	55	7	27	45
		High	0	0	36	0	0	27
SM-9.5	02-1043	None	95	92	73	92	82	36
		Low	5	3	18	8	10	18
		Medium	0	5	9	0	8	45
		High	0	0	0	0	0	0
SM-12.5	02-1041	None	98	92	100	100	90	91
		Low	2	7	0	0	10	9
		Medium	0	2	0	0	0	0
		High	0	0	0	0	0	0
SM-12.5	02-1068 ^a	None	100	42	27	55	0	27
		Low	0	17	18	28	0	36
		Medium	0	30	45	17	12	9
		High	0	12	9	0	88	27
IM-19.0	02-1056	None	100	23	82	100	43	100
		Low	0	35	9	0	28	0
		Medium	0	33	9	0	22	0
		High	0	8	0	0	7	0
SM-19.0	02-1079 ^a	None	100	75	64	100	90	100
		Low	0	3	9	0	5	0
		Medium	0	15	18	0	5	0
		High	0	7	9	0	0	0
BM-25	02-1026 ^a	None	100	74	86	99	3	29
		Low	0	8	0	0	14	29
		Medium	0	8	0	1	30	29
		High	0	11	14	0	53	14
BM-25	02-1050	None	100	42	73	100	98	100
		Low	0	20	27	0	2	0
		Medium	0	32	0	0	0	0
		High	0	7	0	0	0	0

Appendix A presents the data from Table 8 as a series of “stacked column” charts. LWP = left wheelpath; BWP = lane center (between wheelpaths); VTTI = VTTI model; NCHRP 441 = NCAT model (Stroup-Gardiner and Brown, 2000); ICC = International Cybernetics Corporation laser texture device; CTM = circular track texture meter.

^aAreas of segregated mix were evident.

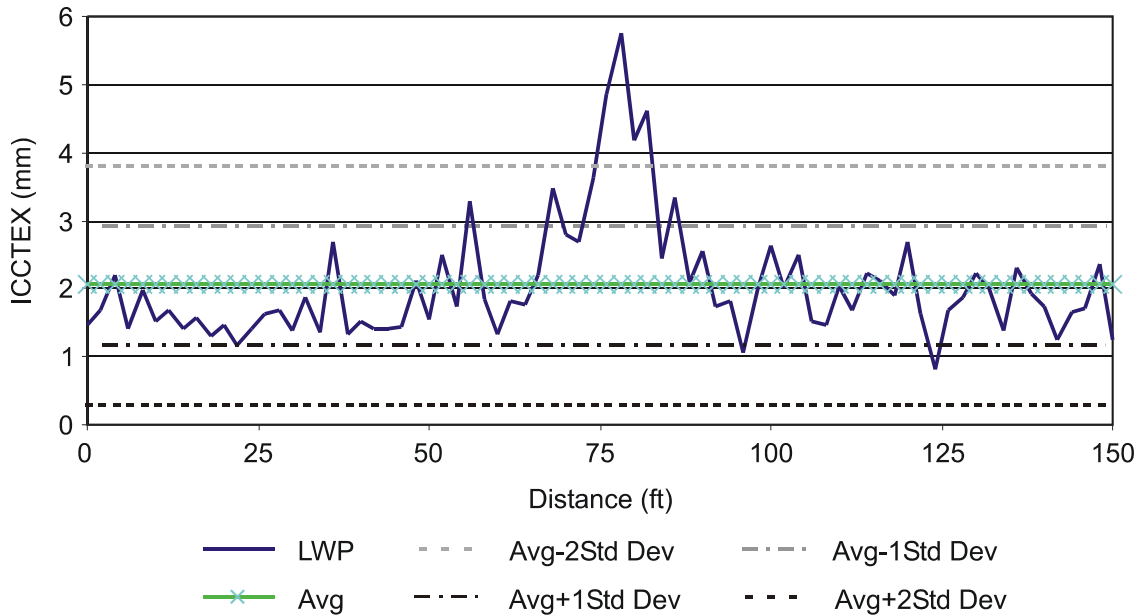

Figure 12. Example of Segregated BM-25 (Project 02-1026). LWP = left wheelpath.

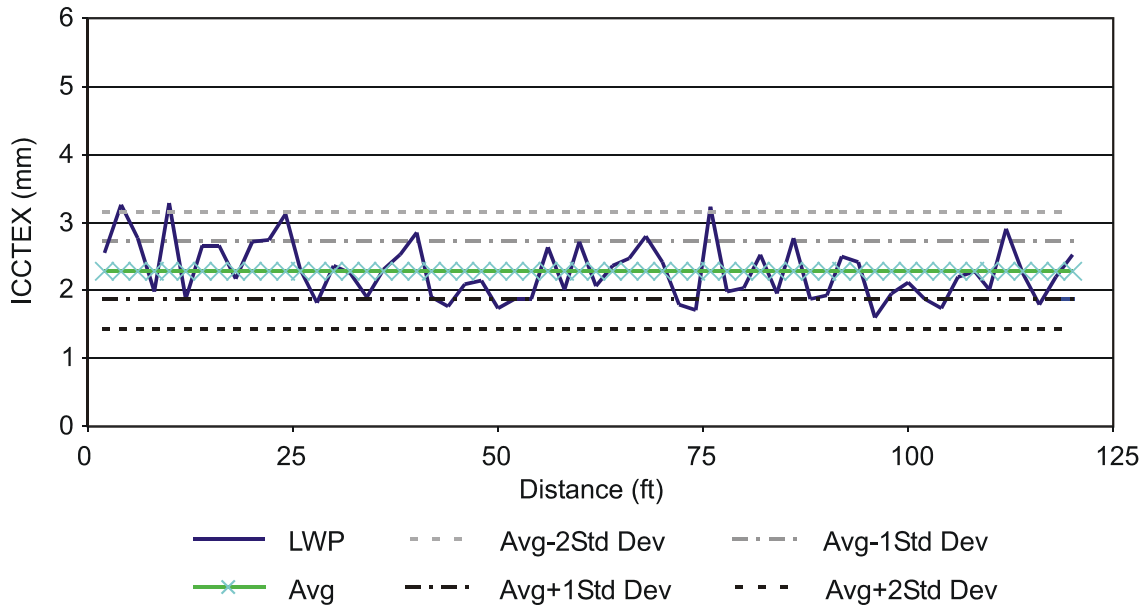

Figure 13. Example of Non-segregated BM-25.0 (Project 02-1050). LWP = left wheelpath.

Assuming that texture data are normally distributed, there are simple conceptual problems with the acceptance bands approach. By definition, about 5% of all data points will exceed 2 standard deviations and 30% will exceed 1 standard deviation, regardless of the actual magnitude of the standard deviation. Although it may be possible to detect subsets of data points with the worst relative performance, there would be no way of knowing whether these subsets were truly segregated on an absolute basis.

Texture Uniformity

This approach is built purely on texture uniformity. Figure 14 shows a texture profile from which information on “well-behaved” (subjectively determined to be uniform) texture can be extracted. The information in Figure 14 is also interesting because it reflects the change in texture that is typical of a construction joint (end/beginning of a day’s placement).

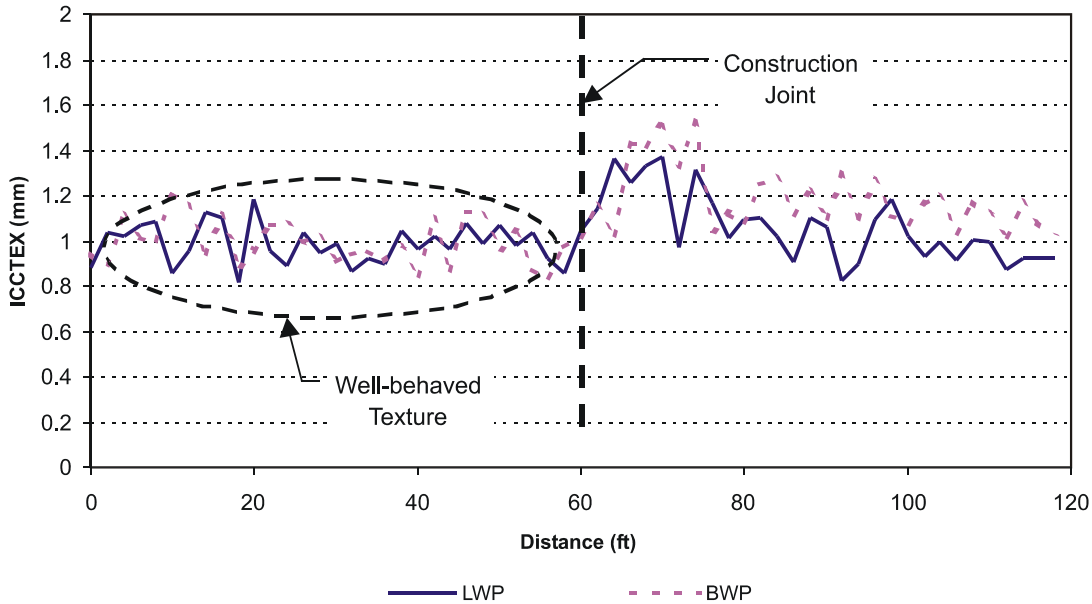

Figure 14. Example Texture Profile with Segment of Good Uniformity (Project 02-1043). ICCTEX = texture estimate from ICC system, LWP = left wheelpath, BWP = lane center (between wheelpaths).

Table 9 summarizes the observed variability for each category of constructed quality. Unfortunately, it is difficult to categorize the behavior of texture. In this instance, “good” behavior was observed in the most uniform portion (pay lot length or 50 ft) of the least segregated test section within a mix type (i.e., for a given NMAS). The overall data from this least-segregated section were used to represent “average” behavior. Finally, the overall data of the notably segregated test sections were selected to represent “bad” behavior. There can be a considerable difference between the wheelpath locations selected for texture measurement. For example, even the reasonably uniform BM-25 mix selected for this project exhibited far more variability in the LWP than in the BWP.

The observations reported in Table 9 were used to develop a quality rating scale (Table 10) for the basis of a uniformity specification. Much of Table 10 was populated through rounding and interpolation. With most mixes, however, the estimates for extreme conditions (i.e., highest incentive work and work requiring corrective action) required extrapolation.

Table 9. Observed Texture Behavior

NMAS	Texture Behavior	Standard Deviation of ICCTEX		
		LWP	BWP	Average
9.5 mm	Good	0.089	0.100	0.095
	Average	0.129	0.129	0.129
	Bad	0.185	0.156	0.171
12.5 mm	Good	0.232	0.174	0.203
	Average	0.268	0.290	0.279
	Bad	0.285	0.375	0.330
19.0 mm	Good	0.195	0.223	0.209
	Average	0.302	0.284	0.293
	Bad	0.536	0.337	0.437
25.0 mm	Good	0.411	0.213	0.312
	Average	0.426	0.232	0.329
	Bad	0.879	1.029	0.954

NMAS = nominal maximum aggregate size, ICCTEX = texture estimate from ICC system, LWP = left wheelpath, BWP = lane center (between wheelpaths).

Table 10. Quality Acceptance Uniformity Rating Scale

Standard Deviation of Texture (mm)				Contract Unit Price Adjustment (% of Pavement Unit Price)
9.5 NMAS	12.5 NMAS	19.0 NMAS	25.0 NMAS	
0.05 and Under	0.10 and Under	0.15 and Under	0.20 and Under	105
0.06 to 0.10	0.11 to 0.20	0.16 to 0.25	0.21 to 0.30	103
0.11 to 0.15	0.21 to 0.25	0.26 to 0.35	0.31 to 0.45	100
0.16 to 0.20	0.26 to 0.30	0.36 to 0.45	0.46 to 0.75	90
0.20 to 0.25	0.31 to 0.35	0.46 to 0.55	0.76 to 1.0	80
Over 0.25	Over 0.35	Over 0.55	Over 1.0	Corrective action required

NMAS = nominal maximum aggregate size.

Table 11 presents the computed contract unit price adjustment factors (%) for the eight test sections evaluated as part of this study. When compared to the results of subjective evaluations and corresponding non-destructive tests, these values appear to be appropriate. For example, the data from Project 02-1026 (see Figure 7) would have suggested an average pay of 80% of the bid unit price and Project 02-1050 (Figure 8) would be considered satisfactory. If the LWP and BWP measurements were considered independently, two sections would have required corrective action. In spite of the reasonable outcome demonstrated by the contents of Table 11, the numbers proposed in Table 10 represent only a starting point. These values will be shadowed against actual texture measurements obtained from a larger group of projects yet to be selected from VDOT’s 2003-2004 construction season. Final “production” targets will not be produced until this exercise is complete.

Table 11. Computed Pay Factors for Test Sections

Project	Mix	LWP ICCTEX			BWP ICCTEX			Avg. Std. Dev.	Comb. Pay Factor (%)
		Avg. (mm)	Std. Dev. (mm)	Pay Factor (%)	Avg. (mm)	Std. Dev. (mm)	Pay Factor (%)		
02-1039	SM-9.5D	1.28	0.185	90	1.39	0.129	100	0.157	90
02-1043	SM-9.5	1.02	0.129	100	1.09	0.156	90	0.143	100
02-1041	SM-12.5	1.59	0.268	90	1.58	0.290	90	0.279	90
02-1068	SM-12.5A	1.56	0.285	90	2.39	0.375	CA	0.330	80
02-1056	IM-19.0	1.71	0.263	100	1.62	0.282	100	0.273	100
02-1079	SM-19.0	1.70	0.536	80	1.45	0.284	100	0.410	90
02-1050	BM-25	2.29	0.426	100	1.48	0.232	103	0.329	100
02-1026	BM-25	2.05	0.879	80	3.49	1.029	CA	0.954	80

ICCTEX = texture estimate from ICC system, LWP = left wheelpath, BWP = lane center (between wheelpaths), CA = corrective action required.

CONCLUSIONS

- *None of the available equations for predicting non-segregated macrotexture worked for all the construction projects evaluated.* The two texture prediction models evaluated performed reasonably well for finer mixes. Unfortunately, neither model proved reliable for larger-stone mixes.
- *The acceptance bands approach produces reasonable results but is significantly influenced by the actual variability within a test section.* Theoretically, and assuming normally distributed data, using acceptance bands ensures that at least some part of the tested sections will fall outside the 1 and 2 standard deviation bands. This approach will likely fail to detect segregated areas in projects with high overall variability, and it becomes very strict in projects with low overall variability.
- *The approach that uses empirically established target standard deviation levels for texture holds promise.* This approach was selected for further testing and pilot implementation. Its simplicity gives it a key advantage, as it does not require the input of mix parameters that is necessary with the predicted texture method. Its effectiveness does build on fairly important assumptions. Specifically, it assumes that texture variability fluctuates proportionally (and consistently) with the NMAS for a mix. It also depends on a reliable relationship between measured texture variability and actual mix uniformity (or lack thereof). Unfortunately, this approach provides little answer for flushed pavements or pavements that may be exhibiting an unusually smooth finished surface. Likewise, this and any other variability-based approach will fail to address situations adequately in which the texture appears uniform as one moves along a pavement even though it may be quite segregated across the lane (e.g., due to a paver malfunction).

RECOMMENDATION

- *VTRC should select a cross-section of projects from VDOT's 2003 Maintenance Resurfacing Schedule to apply a simulated (shadow) application of the proposed special provision for HMA uniformity offered in Appendix B, which incorporates target values for texture variability.* The draft special provision was designed to complement VDOT's Special Provision for Rideability. Table 10 of this report provides a quality acceptance scale for applying price adjustments based on measured variability of texture. In the recommended application, at season's end, the subjective satisfaction with HMA uniformity (absence of segregation) would be compared with the objective assessment provided in the proposed special provision. At that point, any necessary revisions would be made and the revised quality acceptance scale provided to VDOT's Materials Division and Construction Management Division for potential implementation as a pilot special provision for uniformity.

FURTHER RESEARCH

Although this report does not recommend the use of a predicted non-segregated texture as a basis for detecting and measuring HMA segregation, this approach remains an intriguing and potentially viable concept. In many ways, it represents the best approach to account equitably for the subtle differences (e.g., aggregate shape and size) in mixes. It is also superior, in principle, to the other approaches evaluated because it can address lateral segregation and/or "consistent" departures from the job-mix formula that manifest in the exhibited texture. Before this approach can be used with confidence, more research should be conducted, especially on larger-stone and gap-graded mixes.

Other issues relating to texture-based measurement of segregation that should receive further study include (1) the difference in texture measured in the wheelpaths and areas outside and between the wheelpaths, (2) the change in texture attributable to traffic weathering and compaction from construction until the time of testing, and (3) the availability of the HMA properties necessary for predicting a target non-segregated texture level at the time of testing.

Other innovative approaches for detecting and measuring segregations, such as the use of digital imaging, should also be explored. The data reviewed as part of this project suggest that there is a good possibility that *segregated* areas can be identified using image recognition techniques pre-calibrated for typical mixes. These techniques may include processing of high-quality digital images (e.g., photo-logging) of the finished HMA layers. The volume of images used could be "adjusted" by increasing/decreasing the data collection frequency. This approach would have the advantage of providing a better coverage of the paved area and a permanent record (image) of the originally constructed layer. Among other things, these images could help resolve disputes between state officials and contractors.

ACKNOWLEDGMENTS

This project was sponsored by VTRC and VTTI. Special thanks go to L. E. (Buddy) Wood and Troy Deeds of VTRC and Imad Al-Qadi, Amara Loulizi, and Jeff Kuttesch of Virginia Tech for collaborating in the data collection and analysis.

REFERENCES

- American Association of State Highway and Transportation Officials. 1996. *Implementation Manual for Quality Assurance*. Washington, DC.
- American Association of State Highway and Transportation Officials. 2002. *Standard Specifications for Transportation Materials and Methods of Sampling and Testing* (Parts 2A and 2B: Tests). Washington, DC.
- ASTM International. 2002. *Annual Book of ASTM Standards*, Vol. 4.03. West Conshohocken, PA.
- Cross, S.A., and Brown, E.R. 1993. Effect of Segregation on Performance of Hot-Mix Asphalt. *Transportation Research Record 1417*, pp. 117-126. Transportation Research Board, Washington, DC.
- Cross, S.A., Hainin, M.R., and Adu-Osei, A. 1997. *Effect of Segregation on Mix Properties of Hot Mix Asphalt*. Report No. K-Tran:KU-96-6. University of Kansas Center for Research, Inc., Lawrence.
- Davis, R.M., Flintsch, G.W., Al-Qadi, I.L., and McGhee, K.K. 2002. *Effect of Wearing Surface Characteristics on Measured Pavement Skid Resistance and Texture*. Paper presented at Annual Meeting of the Transportation Research Board, Washington, DC.
- Federal Highway Administration. 1997. ROSAN Makes Manual Pavement Testing Obsolete. FHWA-RD-97-011. *Transporter*, January, McLean, VA.
- Flintsch, G.W., Izeppi, E.G., McGhee, K.K., and Al-Qadi, I.L. 2003. Pavement Surface Macrotecture: Measurement and Application. *Transportation Research Record*. Transportation Research Board, Washington, DC. In press for December 2003.
- Henry, J.J. 2000. *Evaluation of Pavement Friction Characteristics*. NCHRP Synthesis 291. Transportation Research Board, Washington, DC.
- Khedaywi, T.S., and White, T.D. 1996. Effect of Segregation on Fatigue Performance of Asphalt Paving Mixture. *Transportation Research Record 1543*, pp. 63-70. Transportation Research Board, Washington, DC.

McGhee, K.K., and Flintsch, G.W. 2003. *High-Speed Texture Measurement of Pavements*. VTRC 03-R9. Virginia Transportation Research Council, Charlottesville.

Ministry of Ontario. 1999. OPSS 313 Special Provision, Specification 103S38. Ontario Provincial Standards Section, Ontario, Canada.

Stroup-Gardiner, M., and Brown, E.R. 2000. *Segregation in Hot-Mix Asphalt Pavements*. NCHRP Report 441. Transportation Research Board, Washington, DC.

Transtec Systems, Inc. 2002. *Pavement Quality Indicator Model 301: Operator's Handbook*. Schenectady, NY.

APPENDIX A

SEGREGATION LEVEL DISTRIBUTION

9.5-mm MNS Surface Mixes

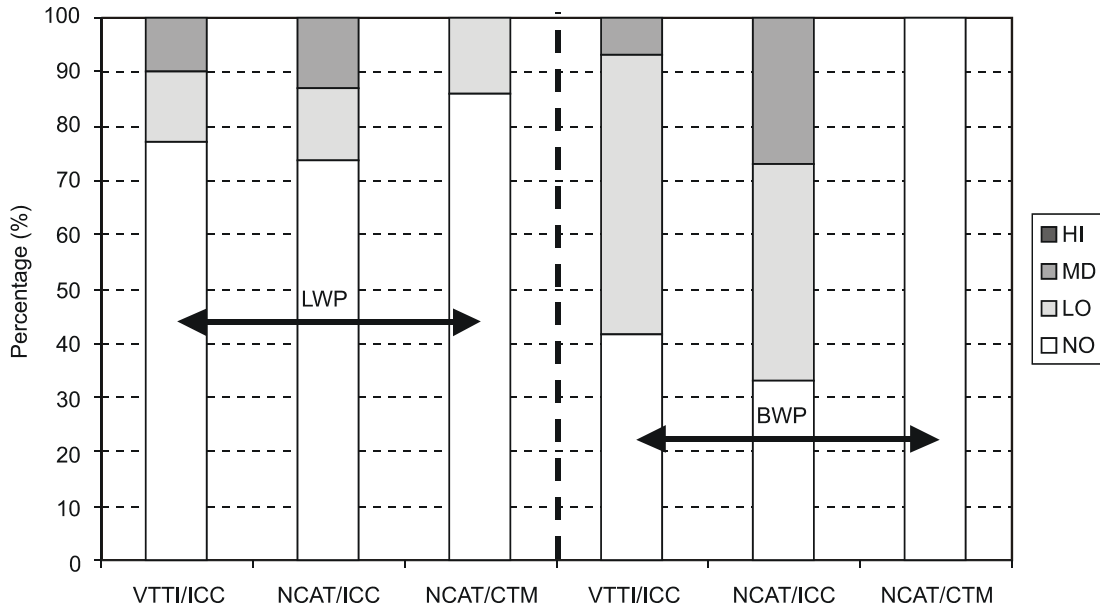

(a) Project 02-1026, Some Segregation Evident

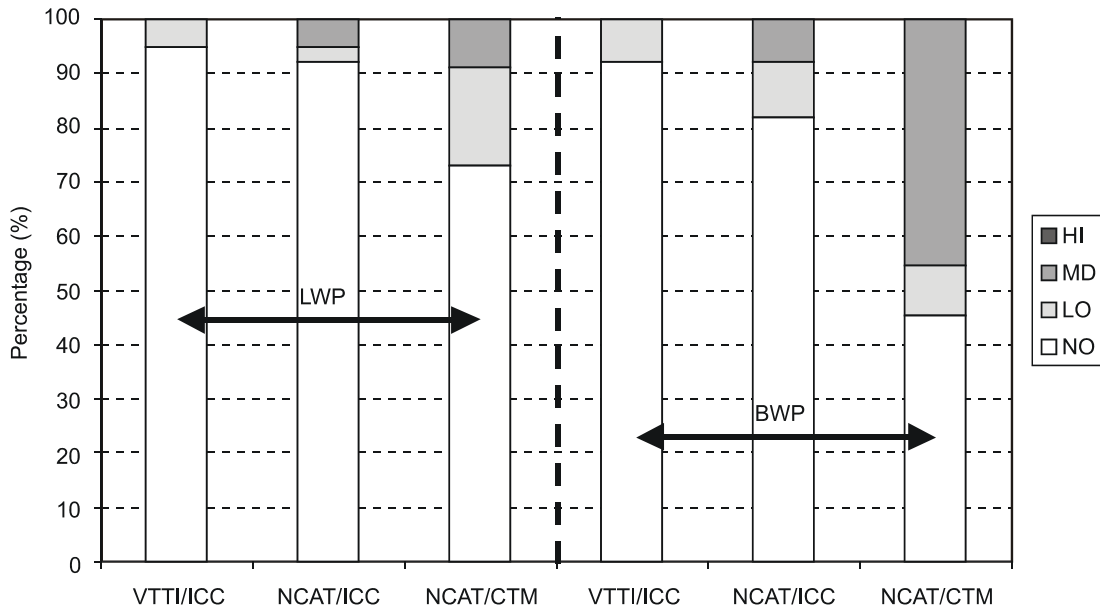

(b) Project 02-1043, Little Segregation Evident

12.5-mm MNS Surface Mixes

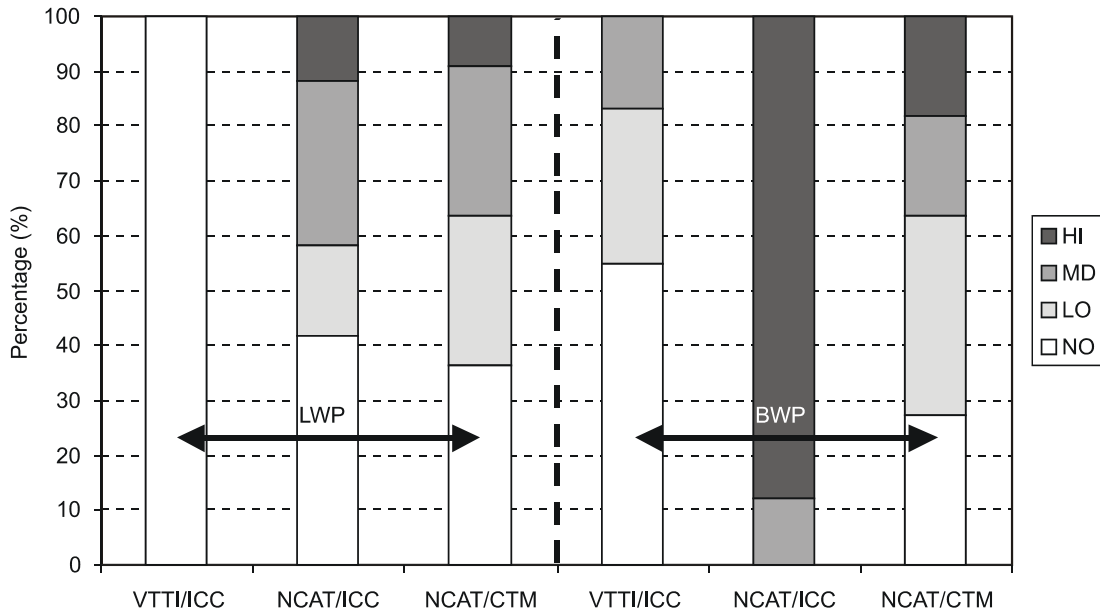

(a) Project 02-1068, Significant Segregation Evident

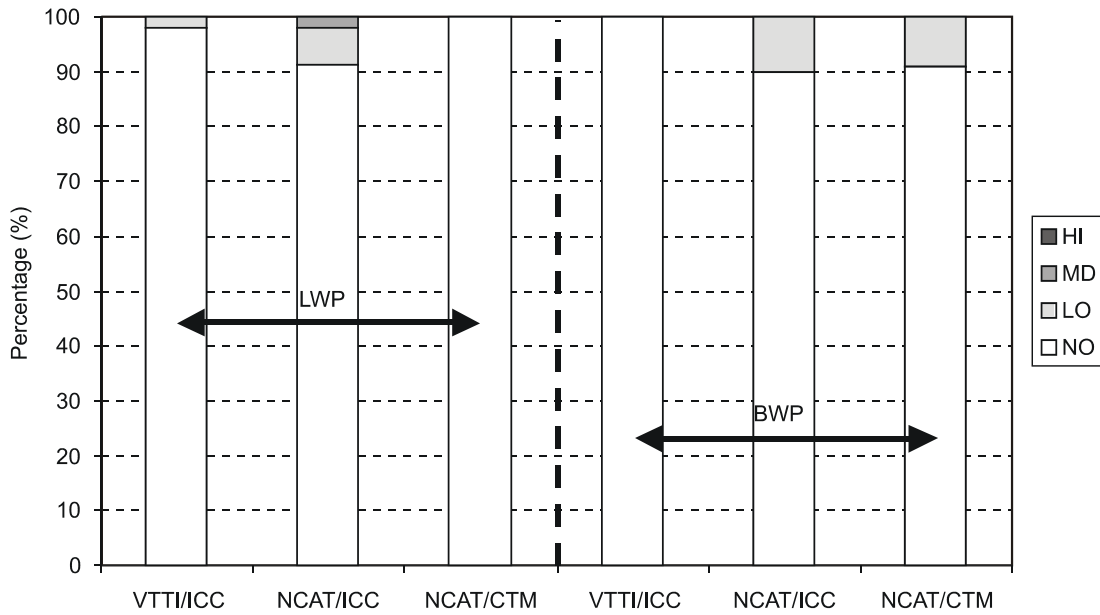

(b) Project 02-1041, Little Segregation Evident

19.0-mm MNS Intermediate/Surface Mixes

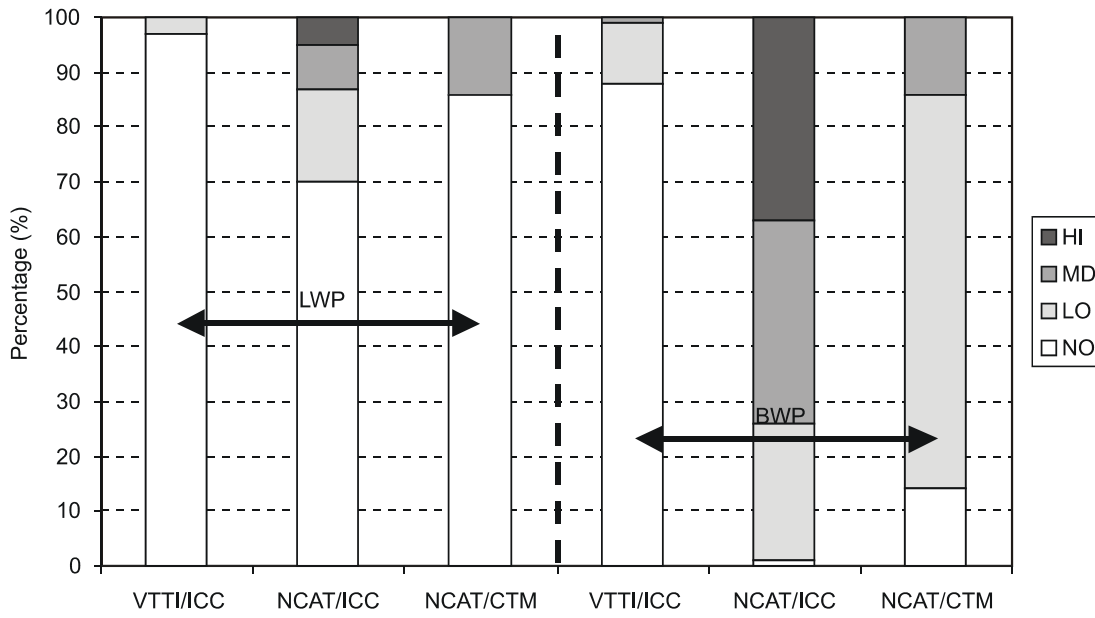

(a) Project 02-1056, Segregation Evident

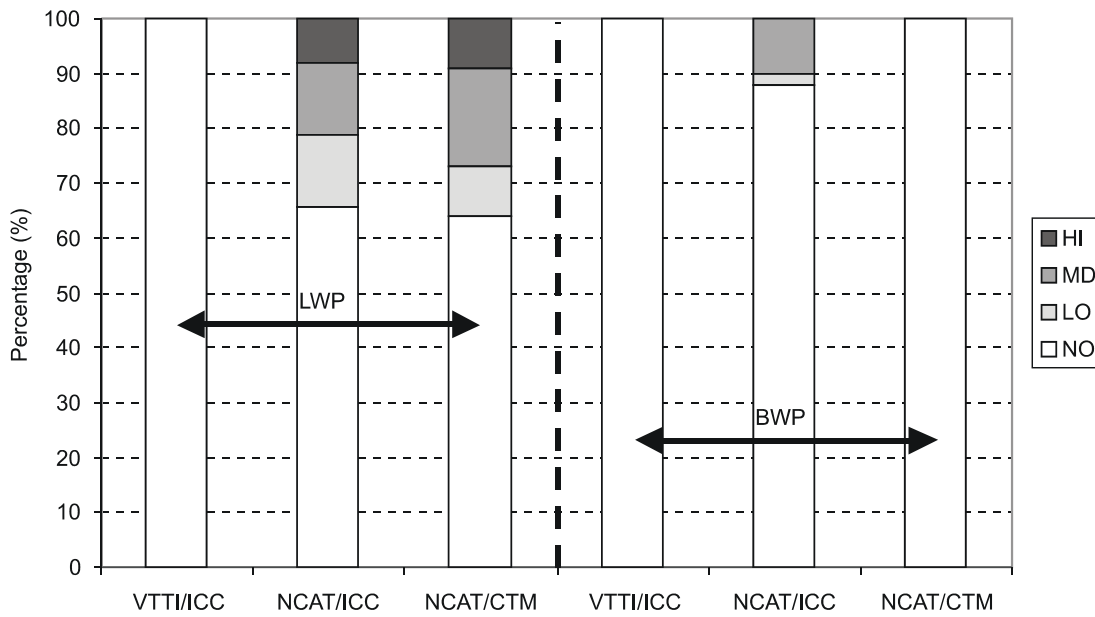

(b) Project 02-1079, Segregation Evident

25.0-mm MNS Base Mixes

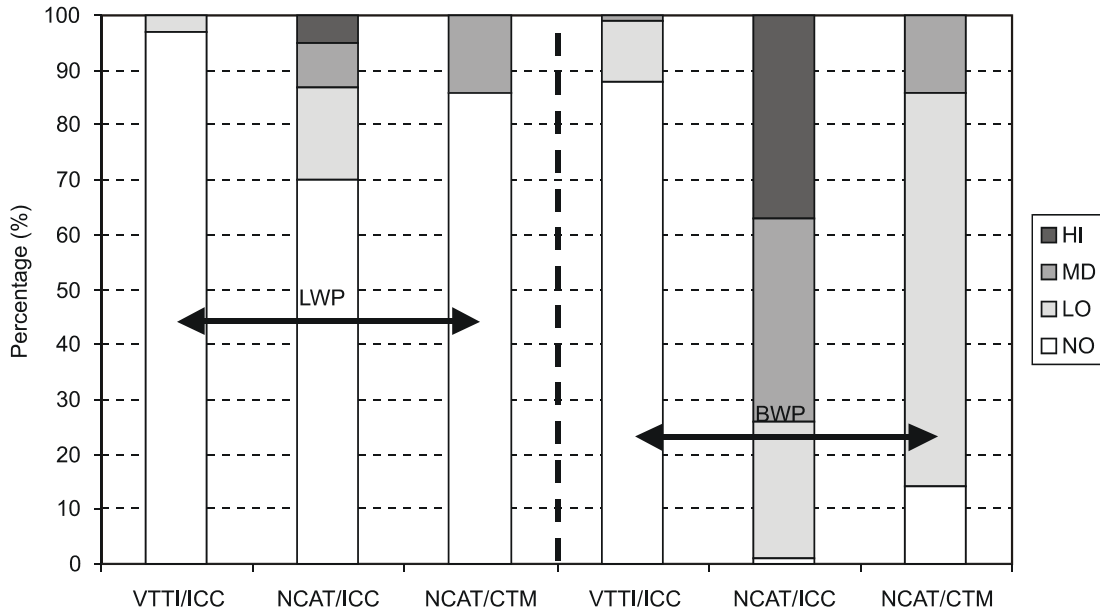

(a) Project 02-1026, Significant Segregation Evident

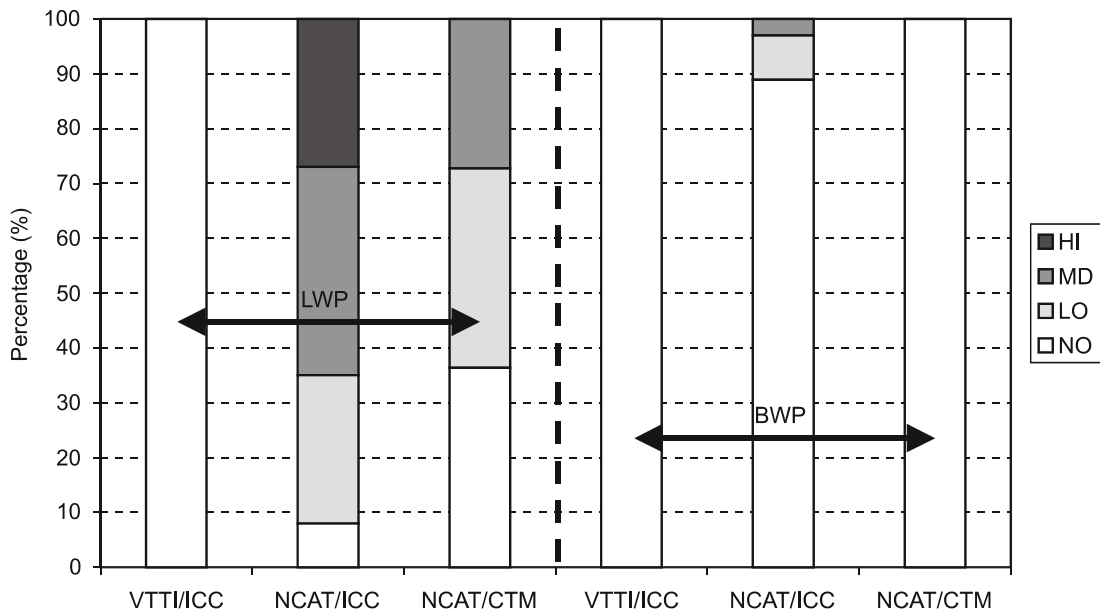

(b) Project 02-1050, Slight Segregation Evident

APPENDIX B

VIRGINIA DEPARTMENT OF TRANSPORTATION SPECIAL PROVISION FOR UNIFORMITY (Imperial)

March 2003

SECTION 315—ASPHALT CONCRETE PAVEMENT of the Specifications is amended as follows:

Section 315.07(c) Surface Uniformity is added as follows:

Pavement uniformity will be determined by the Virginia Department of Transportation's laser-based texture-measuring system.

Except as noted hereinbefore, the surface course uniformity acceptance will be based on the average of two test runs over the length of the project, using a laser-based texture-measuring device, and reported for each travel lane. The device shall provide texture measurements at 2-foot intervals longitudinally for a minimum of two locations laterally along the entire length of the project. These locations shall include a wheelpath and the lane center. The Department shall conduct the testing within 30 calendar days of completion of the final surface course over the designated section, providing the Contractor can allow unimpeded access to the paved surface for constant highway speed test runs. Testing shall be conducted in accordance with the requirements of VTM-###.

Acceptance

An average and standard deviation value for texture will be established for each 0.01-mile section for each travel lane of the surface course. Only those areas of the pavement surface in which handwork was necessary will be exempted from the requirements for uniformity.

Mechanically finished surface that is excluded from testing by the texture meter because of lateral location will be visually assessed for uniformity. If warranted, the texture-measuring equipment will be repositioned and additional measurements made to ensure that uniformity is maintained along all lateral positions of the tested lane. These other lateral positions will be subject to the same acceptance criterion for uniformity as the initially tested positions.

The following table provides the acceptance quality rating scale of pavement based on the final uniformity determination.

Std. Dev. of Texture (mm)				Contract Unit Price Adjustment (Percent of Pavement Unit Price)
9.5 MNS	12.5 MNS	19.0 MNS	25.0 MNS	
0.05 and Under	0.10 and Under	0.15 and Under	0.20 and Under	105
0.06 to 0.10	0.11 to 0.20	0.16 to 0.25	0.21 to 0.30	103
0.11 to 0.15	0.21 to 0.25	0.26 to 0.35	0.31 to 0.45	100
0.16 to 0.20	0.26 to 0.30	0.36 to 0.45	0.46 to 0.75	90
0.20 to 0.25	0.31 to 0.35	0.46 to 0.55	0.76 to 1.0	80
Over 0.25	Over 0.35	Over 0.55	Over 1.0	Remove and replace

Pay adjustments will be applied to the theoretical tonnage of the subject HMA layer for the lane width and section length tested (generally 12 feet wide and 52.8 feet long) based on testing prior to any corrective action directed by the Engineer.

Where corrections are made after the official Department test, the pavement will be retested by the Department to verify that corrections have produced the acceptable uniformity. No incentives will be provided for sections on which corrective actions have been required. The Contractor will have one opportunity to perform corrective action(s).