

**FINAL REPORT**  
**EFFECT OF GIRDER SPACING ON BRIDGE DECK RESPONSE**

**James G. Buckler**  
**Graduate Research Assistant**

**Furman W. Barton**  
**Faculty Research Scientist**

**Jose P. Gomez**  
**Senior Research Scientist**

**Peter J. Massarelli**  
**Research Associate**

**Wallace T. McKeel, Jr.**  
**Research Manager**

(The opinions, findings, and conclusions expressed in this report are those of the authors and not necessarily those of the sponsoring agencies.)

Virginia Transportation Research Council  
(A Cooperative Organization Sponsored Jointly by the  
Virginia Department of Transportation and  
the University of Virginia)

In Cooperation with the U.S. Department of Transportation  
Federal Highway Administration

Charlottesville, Virginia

December 2000  
VTRC 01-R6

Copyright 2000 by the Virginia Department of Transportation.

## **ABSTRACT**

The purpose of this investigation was to evaluate the use of the commercial finite element code ABAQUS for the analysis of reinforced concrete bridge decks and to employ this analysis package to determine the effect of girder spacing on deck response.

A field test was conducted on the Willis River Bridge, and the response, including displacements and strains on the girders and deck surface, was measured. A three-dimensional finite element model was developed to predict the overall structural response of the bridge. Model accuracy was verified with the response data acquired from the field test. Girder displacements, longitudinal and transverse deck strains, longitudinal deck strains, and natural frequencies of vibration were predicted with reasonable accuracy.

The techniques used in the validated finite element model of the Willis River Bridge were implemented to model the Route 257 Bridge over Route 81 in Rockingham County, Virginia. This new model was used in a parameter study to investigate the effects of girder spacing on the stress that develops in the concrete deck. Future phases of this project will include studies that investigate the effect of other parameters such as skew and the need for top reinforcement in reinforced concrete bridges.

## **FINAL REPORT**

### **EFFECT OF GIRDER SPACING ON BRIDGE DECK RESPONSE**

**James G. Buckler**  
**Graduate Research Assistant**

**Furman W. Barton**  
**Faculty Research Scientist**

**Jose P. Gomez**  
**Senior Research Scientist**

**Peter J. Massarelli**  
**Research Associate**

**Wallace T. McKeel, Jr.**  
**Research Manager**

## **INTRODUCTION**

The development of more efficient, high-performance materials, together with more refined and sophisticated analysis procedures, has resulted in bridge structures with longer spans and larger girder spacing. Although these improved design procedures have resulted in savings in weight and cost, the overall result has been that bridge superstructures are more slender and more flexible than ever before. This, in turn, means that bridge components, especially bridge decks, are more susceptible to larger deflections and stresses and, consequently, to faster deterioration. As bridge decks continue to deteriorate, their repair and replacement are becoming an ever-increasing problem for state departments of transportation and the U.S. Department of Transportation. Replacing bridge decks is not only costly, but it also disrupts traffic, poses safety issues, inconveniences the public, and affects the welfare and economy of the community.

Often, a choice needs to be made between repairing a bridge deck and constructing a new one. Key factors in this choice are the strength and deformations of the bridge in its existing form. Unfortunately, a realistic assessment of stresses and deformations in decks that are part of multigirder bridges is not possible using only simplified procedures currently used in design; experimental field tests or advanced computational analysis techniques are required. In many cases, computational analysis is more economical and expedient. However, if such analysis is to become an acceptable alternative to experimental work, it must provide results that are, for practical purposes, comparable to the corresponding experimental data. This may be achieved if the analysis can account for the material and geometric properties of the various components of the structure and interaction among them (Razaqpur, 1990).

## **PROBLEM STATEMENT**

Accurately evaluating the carrying capacity of a bridge has always been one of the more difficult tasks facing bridge engineers. A number of bridges are categorized as structurally deficient because they were designed years ago for smaller loads. When rated with the use of current analytical tools, many of these bridges are found to have insufficient capacity to carry modern traffic loads, resulting in their replacement, strengthening, or load posting. The commonly accepted approach to rating bridges is adherence to the procedures outlined in American Association of State Highway and Transportation Officials' (AASHTO) bridge design specifications (AASHTO, 1994). However, field results indicate that most bridges have a significant reserve strength that is not accounted for by the AASHTO rating procedures. Consequently, bridges that have sufficient strength to remain in service may be rated structurally deficient (Azizinamini, 1994).

The response of new bridges incorporating improved materials and designs is also of concern. New materials for decks, such as high performance concrete, aluminum, and fiber-reinforced composites, hold considerable promise for improved behavior, but relatively little is known about the response of such decks to actual service loads. In addition, improved design procedures may result in changes such as modified reinforcement schemes and wider girder spacing. It is essential that the effect of these types of changes on deck behavior be well understood. The effect of girder spacing, in particular, on deck response is of growing concern among bridge designers.

The Virginia Transportation Research Council (VTRC) initiated a multiphase study to evaluate methodologies that will permit more accurate predictions of bridge response. Recent efforts have focused on the evaluation of finite element capabilities for modeling reinforced-concrete bridge decks and the use of these computational capabilities to investigate the effects of various design parameters on local and global response.

The development of a computational model that will accurately represent the behavior of a reinforced concrete bridge deck is an important step in refining current design and analysis procedures. Such a model should include the capability for representing not only the nonlinear behavior of reinforced concrete but the cracking behavior as well. When such a model is developed and verified for accuracy, it can then be used as a template for modeling similar reinforced-concrete bridge decks with different dimensions and different configurations. Manipulation of these models will allow researchers to examine the effect changing various parameters of a bridge will have on its response.

## **PURPOSE AND SCOPE**

This investigation was one phase of a long-range study on the response of reinforced-concrete bridge decks conducted by VTRC staff. The long-term objective is to develop a capability for accurately modeling any reinforced-concrete bridge deck and to employ this capability to evaluate the effect of various design parameters on bridge deck response. The focus

of the part of the study reported here was an evaluation of the effect of girder spacing on the characteristics of bridge deck response such as deflection, stresses, and cracking.

Accordingly, the objectives of this investigation were twofold:

1. to develop a computational capability for analyzing bridge decks and to validate this procedure by comparing predicted analytical responses and experimental response data for an actual bridge
2. to evaluate the effect of girder spacing on deck response by developing models of different deck designs based on different girder spacing and to employ these models to predict corresponding stresses and deflections.

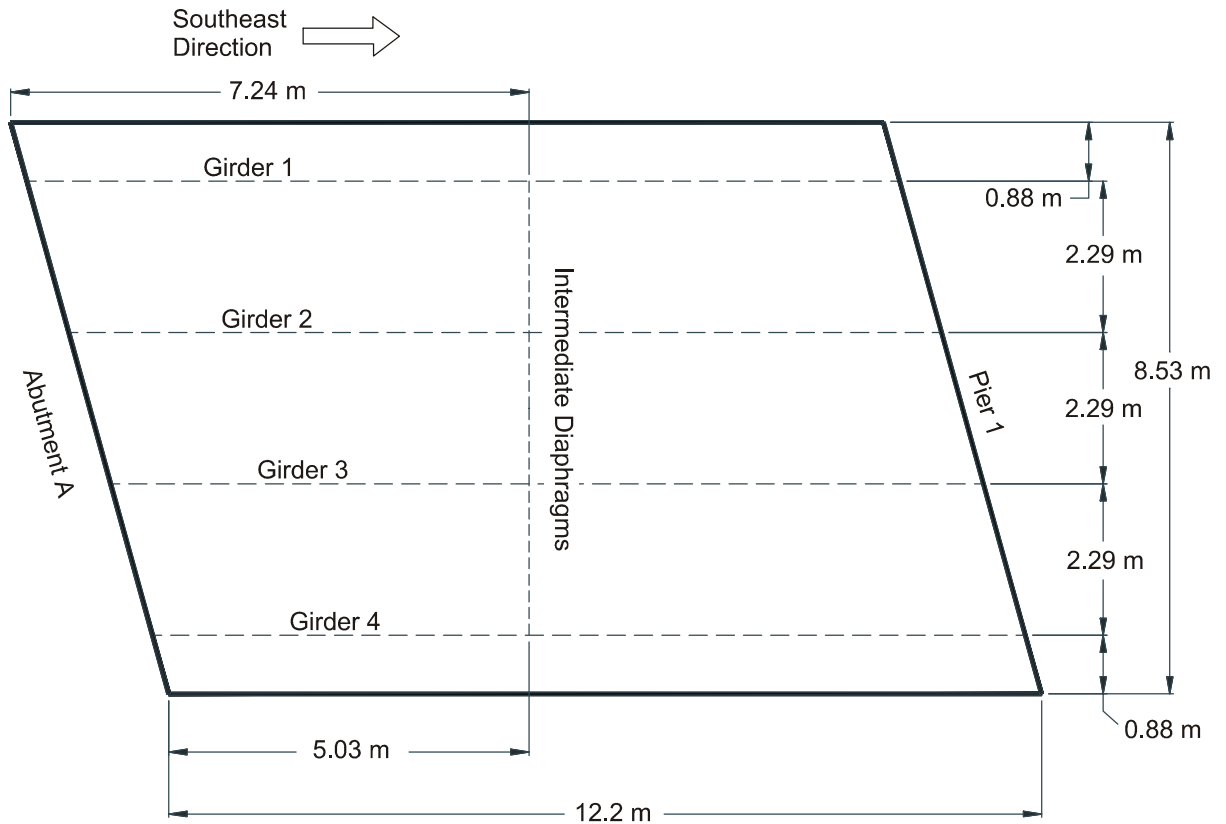
## METHODOLOGY

To accomplish the study objectives, four tasks were performed:

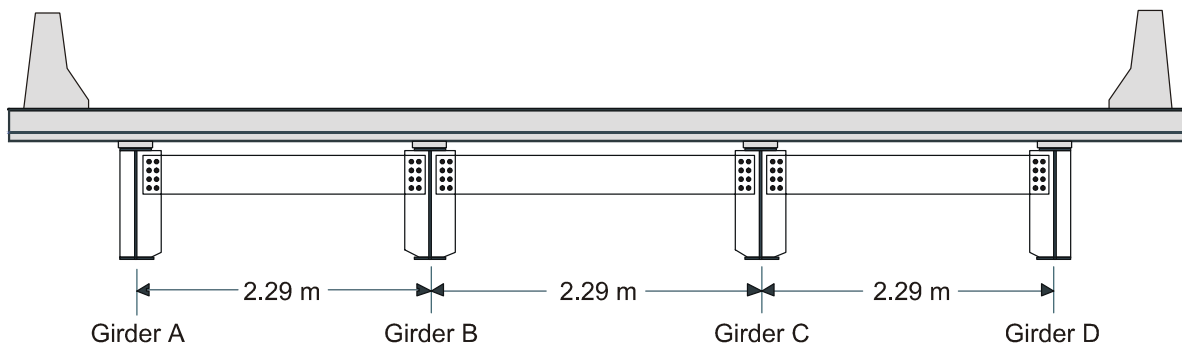
1. Develop a finite element model of a slab-girder bridge with a reinforced concrete deck.
2. Conduct a field test to gather experimental data that could be used to verify the finite element model.
3. Extend the finite element modeling concept to generic bridges with longer spans and widths and different girder spacing, which are more representative of the bridges in Virginia.
4. Use these new generic bridges in a parameter study in which the effect of girder spacing on deck response is investigated.

The analytical and experimental work involved in the development and validation of a reliable finite element model required the selection of a bridge as the basis for the work. The Willis River Bridge was chosen as the candidate structure for validating the predicted response of the computer model. This structure was chosen based on its proximity to VTRC and because of its accessibility for field testing purposes.

The Willis River Bridge is located on Route 621 in Buckingham County, Virginia, and consists of a doubly reinforced concrete slab supported on four steel girders. The girders are supported laterally via diaphragms. Reinforced concrete parapets not only serve as a traffic barrier but also stiffen the deck. The bridge is a three-span structure with all spans simply supported. Each span has a length of 12.2 m (40 ft) and a width of 8.5 m (28 ft). The four girders are spaced at 2.26 m (7.4 ft), and the bridge has a skew of 15 degrees. A plan view and cross section of the bridge are given in Figures 1 and 2. Additional details of the bridge, such as deck reinforcement, are provided in a previous report (Buckler, 2000).



**Figure 1. Plan View of Test Span of Willis River Bridge**

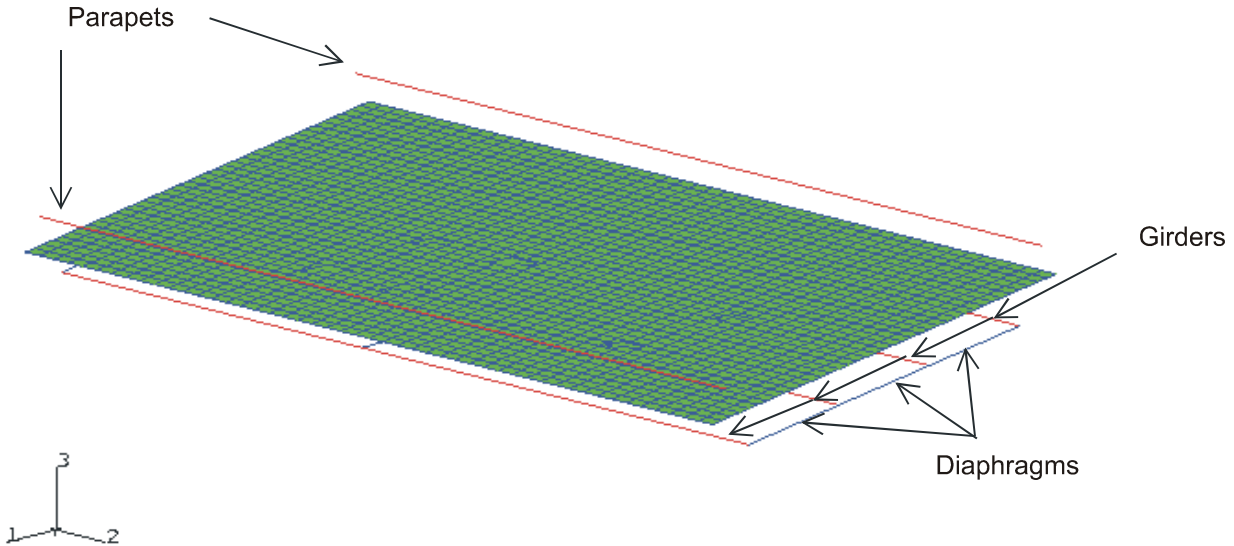


**Figure 2. Cross-Section View of Willis River Bridge**

### **Development of Finite Element Model**

Many commercial finite element codes incorporate advanced modeling techniques developed for material models of concrete, reinforcement, and interaction behavior. This study employed the latest technology in computer modeling to simulate and evaluate the response of a reinforced concrete bridge. The commercial finite element code ABAQUS (Hibbitt, Karlsson & Sorenson, Inc., 1998), which contains special modeling procedures for reinforced concrete, was used in this study for the development of the finite element bridge models.

Since the spans are simply supported, the response of each span is independent of the other spans and, thus, only the end span between the abutment and the first pier was modeled (Span A). This is also the span for which experimental data were obtained. Figure 3 shows the finite element model developed for the Willis River Bridge. The concrete deck was modeled using 1,824 shell elements, with each element being 247.65 mm (9.75 in) wide by 254 mm (10 in) long by 247.65 mm (9.75 in) thick. The four girders are represented by 192 beam elements, with each element being 254 mm (10 in) long. The parapets were also modeled with beam elements, and truss elements were used to represent the diaphragms.

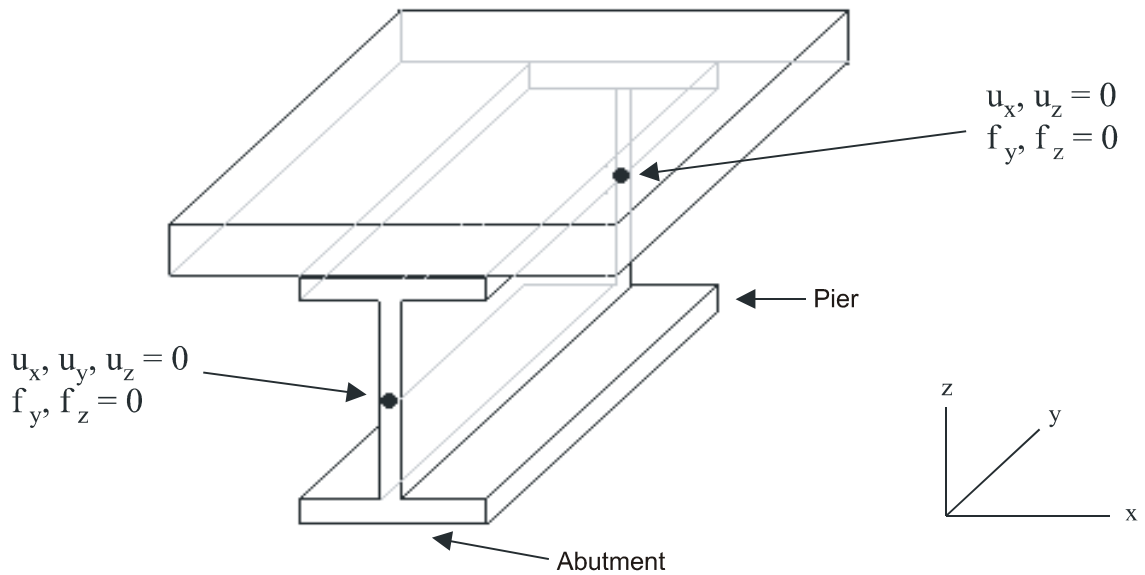


**Figure 3. Finite Element Model of Span A of Willis River Bridge**

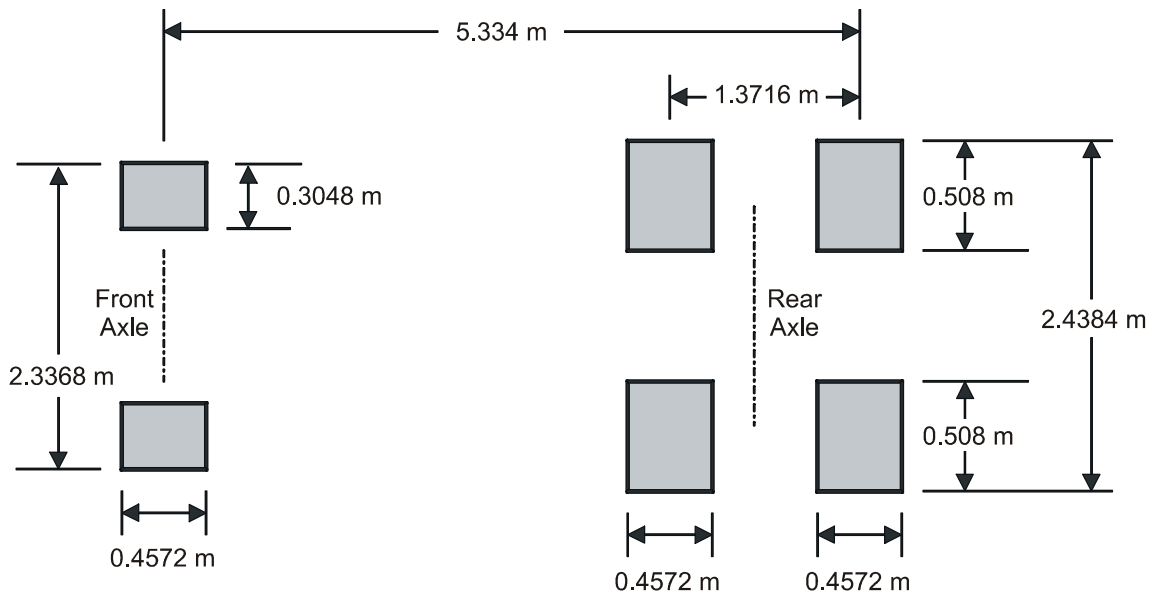
The boundary conditions used in this study were as follows. The displacements were restrained in the  $x$ -,  $y$ -, and  $z$ - directions, and rotations were restrained about the  $y$ - and  $z$ - axes at one end node of each girder. The girders were allowed to rotate only about the  $x$ -axis. At the other end node of each girder, zero displacement was imposed on the  $x$ - and  $z$ - degrees of freedom along with zero rotation about the  $y$ - and  $z$ - axes. The girder was allowed to displace longitudinally (in the  $y$ - direction) and allowed to rotate about the  $x$ -axis. These displacement degrees of freedom along with the coordinate system used for this analysis are shown in Figure 4.

Typically, in any finite element code such as ABAQUS, loads can be applied to either an element or a node. This restricts the precise location where loads can be applied and makes moving the load around the applied surface more difficult. In this study, the loading consisted of a specific vehicle with wheel and axle spacing fixed. A “load patch” was created that consisted of six shell elements that had the same spacing as the wheels of the dump truck used in the field tests of the Willis River Bridge. The element dimensions of this load patch represented the surface area of the wheels of the dump truck that was in contact with the road surface. This load patch, shown in Figure 5, allowed placement of the loads anywhere on the deck. The load patch was attached to the deck by means of contact elements, another convenient feature of ABAQUS.





**Figure 4. Boundary Conditions Used in Finite Element Model**



**Figure 5. Load Patch Layout and Dimensions**

Without the use of this load patch, the location of the actual wheel loads could be only approximated.

The elements used to define this load patch were shell elements, similar to those of the deck, but the material properties defining the elements were significantly different. It was imperative that the load patches not carry any of the loads imparted on the bridge by the truck

but simply serve to transfer the loads directly to the deck. To ensure that no load was carried by the elements of the load patch, several studies were conducted. The results of these studies showed that a very thin load patch with an extremely low modulus of elasticity would achieve this goal. The modulus of elasticity used to define the load patch material was  $0.69 \text{ kN/m}^2$  (0.1 psi), and the thickness was 1.27 mm (0.05 in).

The load was applied to the patch as a pressure load evenly distributed on the elements representing the patch. The weight of the rear axle of the truck was 174.456 kN (39,220 lb), which translated into a pressure on the elements representing the rear wheels of  $187.8 \text{ kN/m}^2$  (27.24 psi). Similarly, the front axle weighed 66.98 kN (15,060 lb), which corresponded to a pressure of  $240.37 \text{ kN/m}^2$  (34.86 psi) per element making up the front axle.

The finite element model of the bridge was subjected to the test vehicle load applied at various locations on the bridge, and response information, such as deflections, stresses and strains, was calculated. These values of predicted response were subsequently compared with corresponding response data measured experimentally during the field tests.

### **Field Test**

The purpose of the field test was to obtain experimental response information for the Willis River Bridge under different loading conditions. The data obtained were then compared with analytical results to validate the finite element model. Once the model was verified, the techniques used in developing the finite element model could be used to model other reinforced-concrete bridges with some measure of confidence.

Instrumentation for the field test was designed to measure displacements of the four girders, longitudinal strains in the flanges of the four girders, transverse deck strains midway between the three sets of girders, and the natural frequency of the bridge. Electrical resistance strain gages, weigh-in-motion (WIM) gages, and cantilever deflection gages (CDG) were used to obtain strain and deflection data from the steel girders and reinforced-concrete deck. Accelerometers were used to determine the natural frequency. All of the data were recorded at the midspan of Span A.

The girder deflections were measured for all four girders using CDGs that were attached to the lower flanges of each girder at the midspan of the bridge. A CDG consists of a triangular steel plate instrumented with a strain gage. The plate is attached to the bottom flange of the girder using C-clamps, and a weight, suspended from the tip of the plate, rests on the ground below. A strain gage is permanently attached to the plate, and the correlation between the plate's strain and deflection is predetermined. The suspended weight imparts an initial strain on the plate. As the bridge deflects, the strain in the plate decreases. This change in strain is transformed into a deflection and recorded.

The longitudinal strain in the flanges of the girders was measured using electrical resistance strain gages. These gages were attached to flanges of the girders using an epoxy. Both the top and bottom flanges of Girders 1 and 2 were instrumented with these strain gages.

The bottom flanges of Girders 3 and 4 were instrumented with strain gages. All of the gages in the flanges were oriented in the longitudinal direction.

Five WIM gages were used to measure the strain in the bottom of the concrete deck. Three gages (one between each set of girders), placed on the underside of the deck midway between each set of girders, were oriented in the transverse direction, giving the transverse strain in the bottom of the deck. The fourth WIM gage was oriented in the longitudinal direction near the interface between the top flange of Girder 2 and the bottom of the concrete deck. The fifth WIM gage was also placed near the interface between the top flange of Girder 2 and the bottom of the concrete deck, but it was oriented in the transverse direction.

Four accelerometers were used to determine the natural frequency of the bridge. One accelerometer was placed on the top of the bottom flange of each girder. Again, they were located at the midspan of Span A.

A VDOT dump truck filled with gravel was used as the applied load on the bridge. The truck wheels had the same dimensions as the load patch shown in Figure 5, which shows the surface area of the wheels in contact with the bridge. The total weight of the truck was 240.81 kN (54,140 lb). The front axle weighed 66.98 kN (15,060 lb), and the rear axle 174.45 kN (39,220 lb).

To allow observation of the full response of the bridge under loading, the truck crossed the bridge at different transverse locations and speeds, and the deck response was measured for each loading. The locations were picked to maximize the strains in the deck or the deflection of the girders. Seven load cases at three speeds with two runs at each load case were used. An average value for displacements and strains at each gage was computed and reported as the experimental response. The truck's location and speed for each load case are given in Table 1. The static load cases, Load Case 1 through 3, were defined as those test runs with a vehicle speed of 8.05 km/h (5 mph). The maximum deflection would be expected to occur when the truck's center of gravity was directly over the centerline of Span A.

**Table 1: Load Case Descriptions**

Load Case	Truck Location	Speed (km/h)
1	Left lane (straddling Girder 2)	8.05
2	Centerline	8.05
3	Right lane (straddling Girder 3)	8.05
4	Right lane (straddling Girder 3)	72.42
5	Left lane (straddling Girder 2)	72.42
6	Right lane (straddling Girder 3)	40.23
7	Left lane (straddling Girder 2)	40.23

Four dynamic load cases or eight dynamic test runs were used. The dynamic tests differed from the static tests only in the speed at which the test truck traveled across the bridge. In the dynamic tests, the truck traveled at two speeds, 72.42 km/h (45 mph) and 40.23 km/h (25 mph). Data were collected 4 times for each speed, twice while the truck traveled in the right lane and twice while the truck traveled in the left lane. The truck's location and speed for the four

dynamic load cases are described in Table 1. The data collected from the dynamic tests were used to determine the natural frequency of the bridge.

The experimental response data measured during the field tests were compared with the predicted response from the analytical model of the bridge as a means of validating the response from the computer model.

### **Design of Generic Bridges for Girder Spacing Study**

Modeling and testing of the Willis River Bridge were conducted to validate the modeling procedures used. However, data from this bridge alone were insufficient to use as a basis for evaluating the effect of girder spacing. To accomplish this evaluation, three bridge designs, referred to as Bridges A, B, and C, were developed, each with different girder spacing. The designs were patterned after the Route 257 Bridge over Route 81 in Rockingham County, Virginia.

Several modifications were made to the design of the Route 257 Bridge to accommodate the design software available and to facilitate development of the finite element models for the three bridges, including

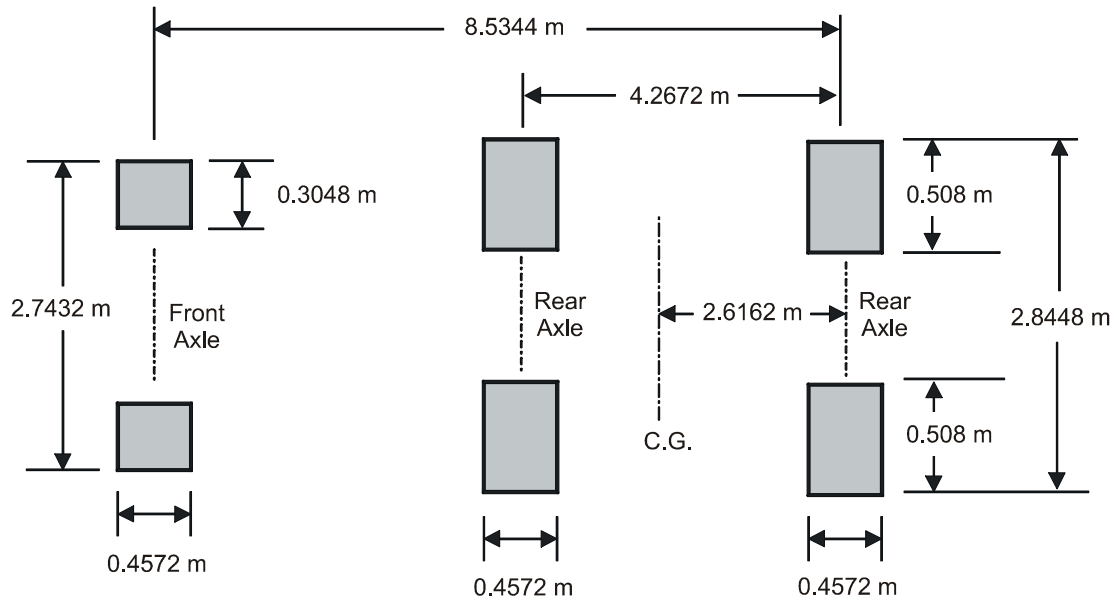
- replacing the haunched girders with plate girders having a constant web height
- removing the 5-degree skew angle and designing the bridge with no skew
- having simply supported spans.

The Route 257 Bridge, with a span of 48.8 m (160 ft), is more typical of multigirder bridges in Virginia than is the Willis River Bridge. The objective for the three bridge designs, while conforming to the design standards provided by AASHTO, was to keep them as similar as possible except for girder spacing. Each bridge had a span of 48.8 m (160 ft) and a reinforced-concrete deck with a thickness of 215.9 mm (8.5 in) and a width of 26 m (85.4 ft). The deck was doubly reinforced with longitudinal and transverse reinforcement.

Bridge A had 14 girders with a girder spacing of 1.83 m (6 ft); Bridge B had 10 girders with a spacing of 2.67 m (8.75 ft); and Bridge C had 8 girders with a spacing of 3.43 m (11.25 ft). The AISI Beam Design Program was used to determine the girder dimensions for a given girder spacing, span length, and slab thickness (Taavoni, 1997). The depth of the girders for Bridges A and B was 1.98 m (6.5 ft) and that for Bridge C was 2.24 m (7.35 ft). Additional details of the design, including reinforcement details and girder dimensions, are provided by Buckler (2000).

A finite element model was developed for each of the three bridge designs. These models used the same techniques used in modeling the Willis River Bridge. The load applied to the bridge was that specified by AASHTO. It consisted of an HS-20 truck with a 4.267-m (14-ft) spacing between the front and middle axles and between the middle and rear axles. A load patch

was again used for transmitting the load to the bridge model. The properties of the load patch were the same as those described for the load patch used for the Willis River Bridge, but the geometry and magnitudes of the loads were different. Figure 6 shows the load patch used to load the three bridges in the parameter study.



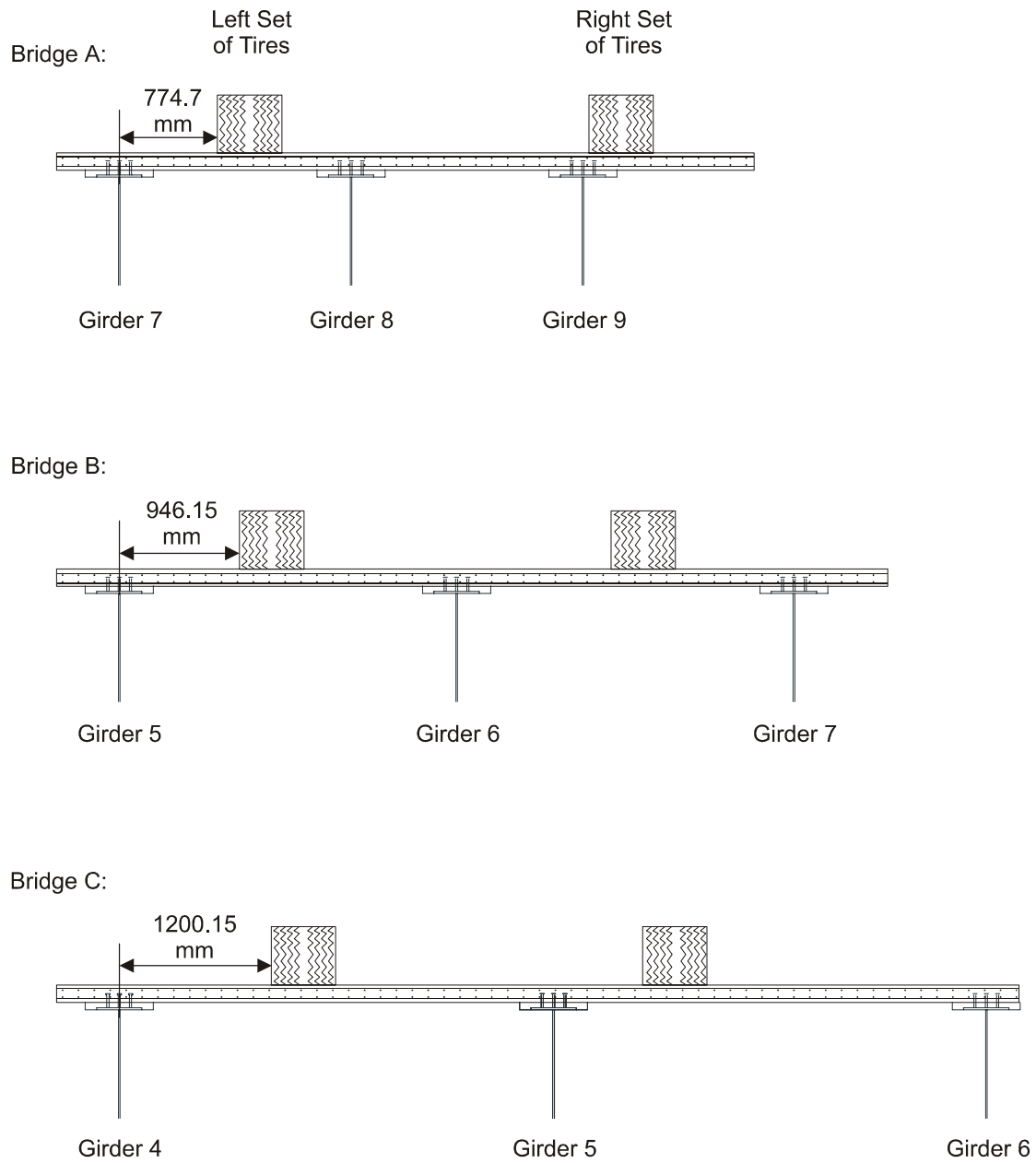
**Figure 6. Load Patch Used to Represent HS-20 Truck Load**

The center of gravity of the truck was placed over the midspan of each bridge. This gave the longitudinal location of the truck that provided the maximum stress in the deck. The transverse location of the truck that yielded the maximum stress in each bridge was determined by shifting the load incrementally across the center portion of each bridge (see Figure 7). For each bridge, deflections, strains, and cracking behavior were calculated for all load applications, but the data used to evaluate the effect of girder spacing were based on the loading that produced the maximum response.

## RESULTS AND DISCUSSION

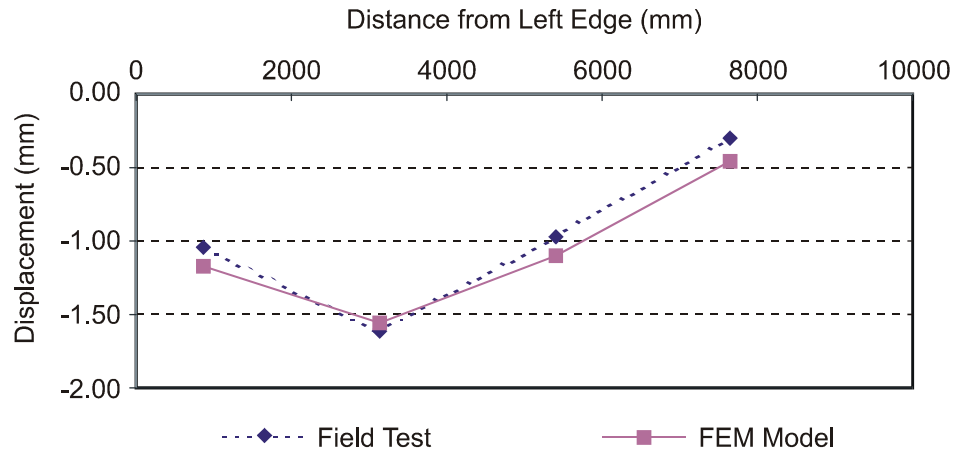
### Development and Validation of the Finite Element Model

The girder deflections for the three static load cases predicted by the model and measured during the field test are shown in Figures 8 through 10. The deflections predicted by the finite element model closely matched the actual response measured during the field test. The data points in each graph represent the midspan deflection of Girders 1 through 4 going from left to right on the plot. The average difference in predicted deflection was 0.12 mm (0.0047 in), and the maximum predicted and measured deflections were essentially identical.

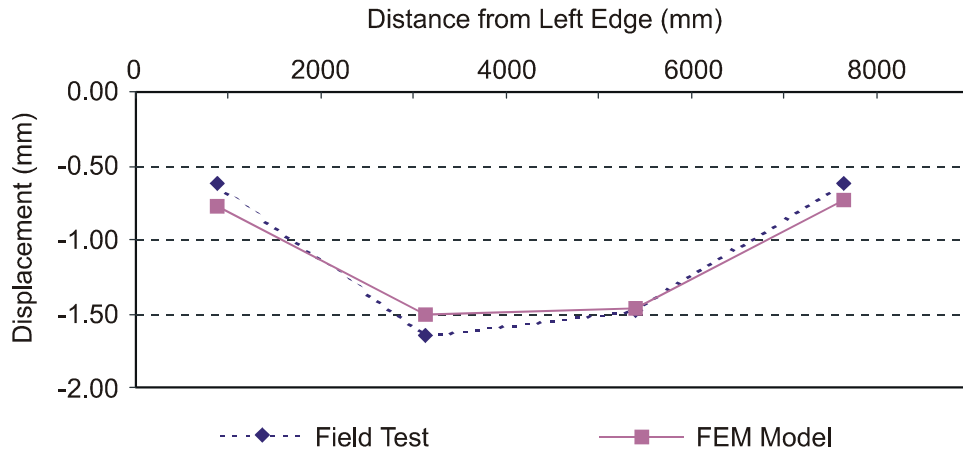


**Figure 7. Truck Locations That Provide Maximum Stress in Deck for Bridges, A, B, and C**

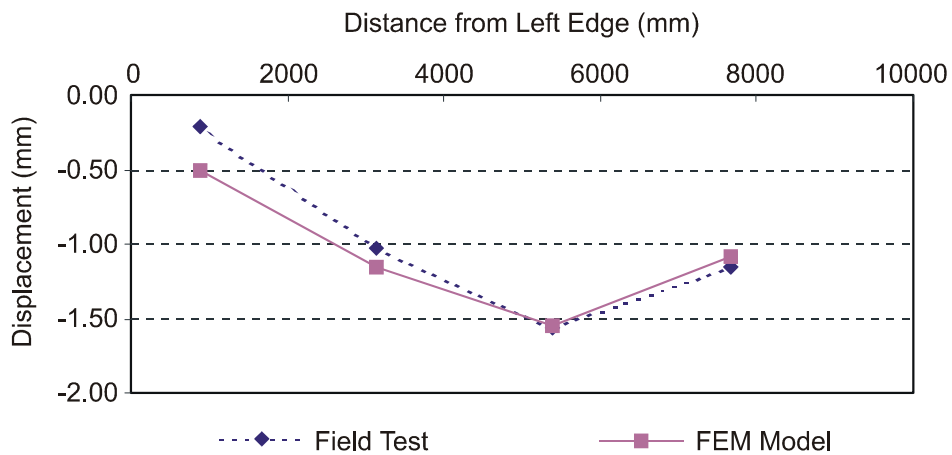
The strain data predicted by the finite element model and measured in the field also matched quite closely. The plots in Figures 11 through 13 show the transverse strain in the bottom of the deck as predicted by the finite element model and from the field test. The data points in the figures correspond to the locations of the WIM gages in the field test, i.e., at midspan halfway between the girders. The average difference between the predicted and measured strains was 6.3 microstrain, or  $6.3 \times 10^{-6}$  mm/mm. These values of strain are very small since they pertain to a small load on a relatively stiff bridge.



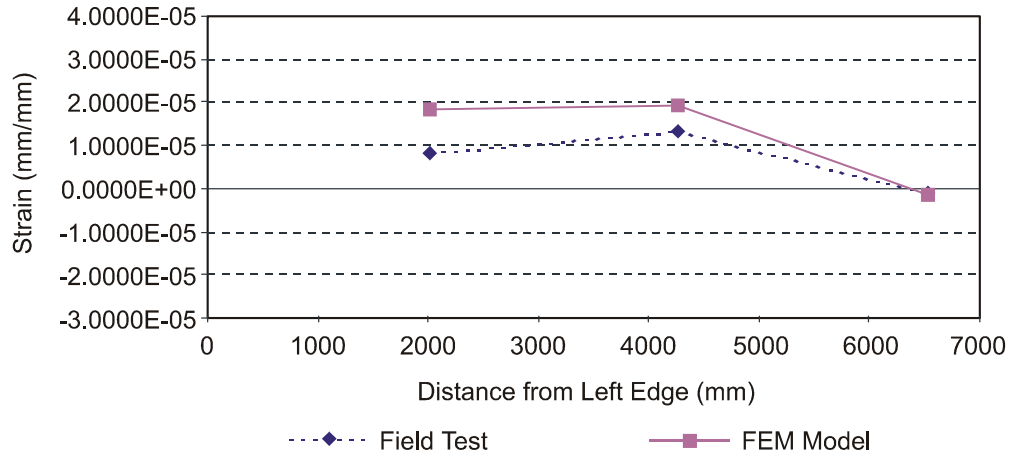
**Figure 8. Displacement Comparison for Static Load Case 1**



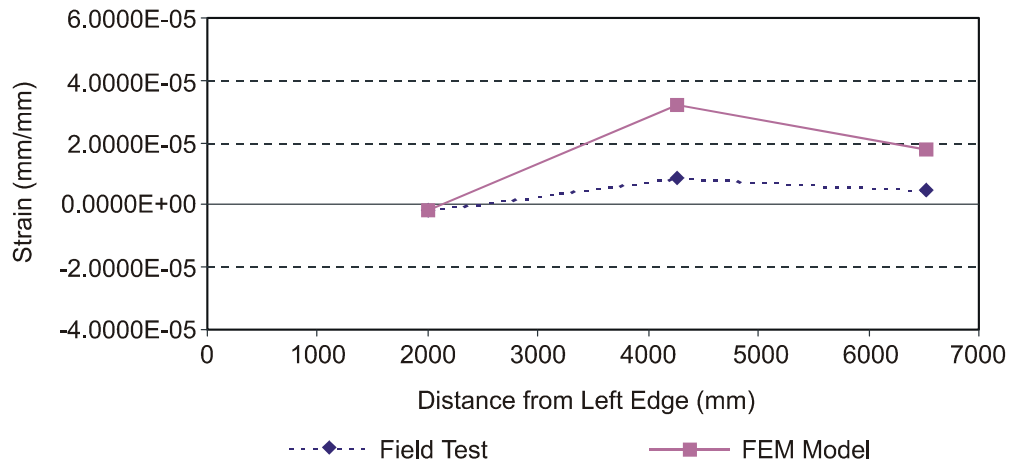
**Figure 9. Displacement Comparison for Static Load Case 2**



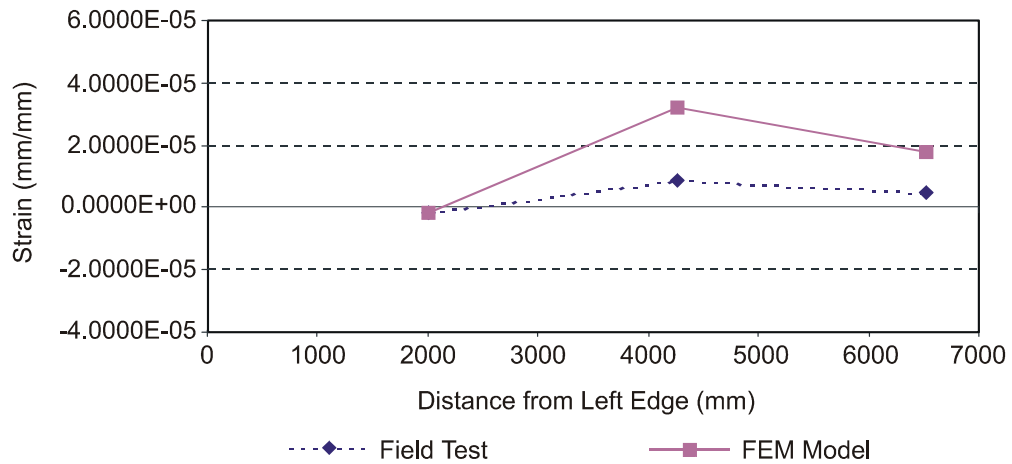
**Figure 10. Displacement Comparison for Static Load Case 3**



**Figure 11. Strain Comparison for Static Load Case 1**



**Figure 12. Strain Comparison for Static Load Case 2**



**Figure 13. Strain Comparison for Static Load Case 3**



Although not directly related to the validation of the model, it is of interest to examine how the model may be used to show stresses throughout the deck. Figures 14 and 15 show contours of transverse and longitudinal stress throughout the deck. This type of information, which could be very useful to bridge engineers, is simply not available from field tests and, thus, is another factor showing the value of using computer models for bridge evaluation.

The dynamic analysis to determine the natural frequencies of the bridge provided more verification that the finite element model and the actual bridge were yielding the same results and responding to loading in similar fashions. From the analytical model, the fundamental natural frequency of the Willis River Bridge was determined to be 11.8 Hz. This value matches very closely the data collected during the field test. The four accelerometers used to measure the natural frequency of the bridge all recorded a natural frequency of 11.6 Hz.

The comparison of the response data collected in the field test and the response data predicted by the finite element model indicated a very good correlation between deflections, strains, and frequencies. Because of this strong correlation between the predicted and field results, the finite element model developed appears capable of accurately modeling the response

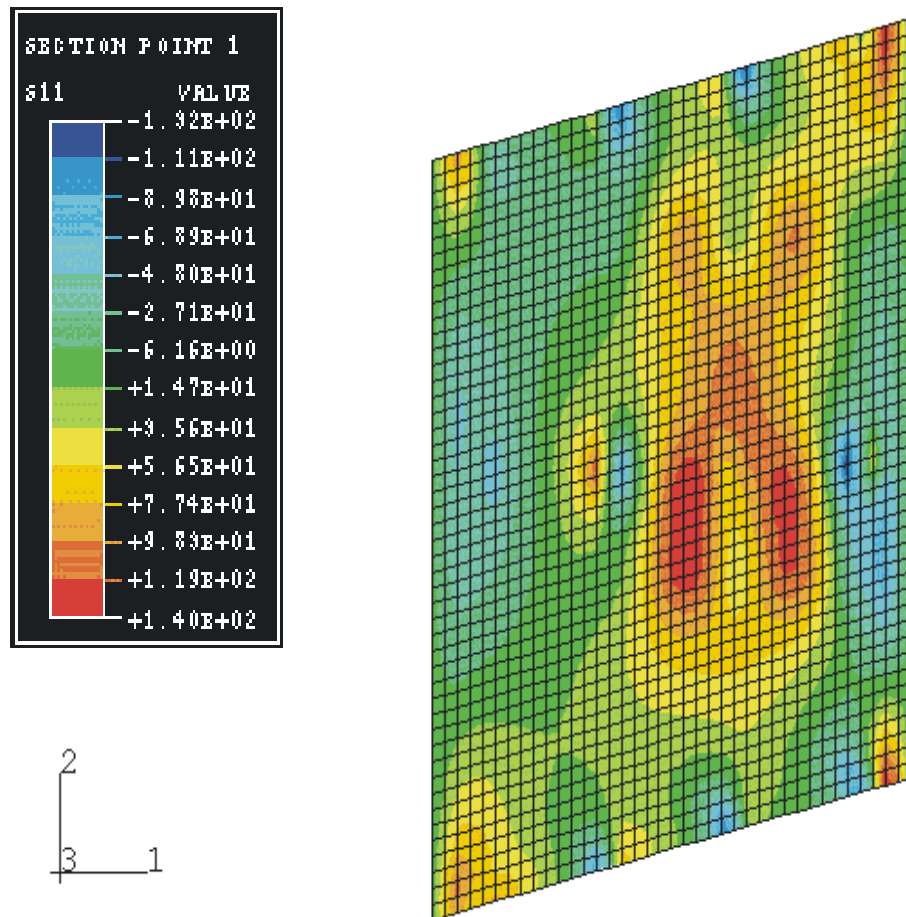
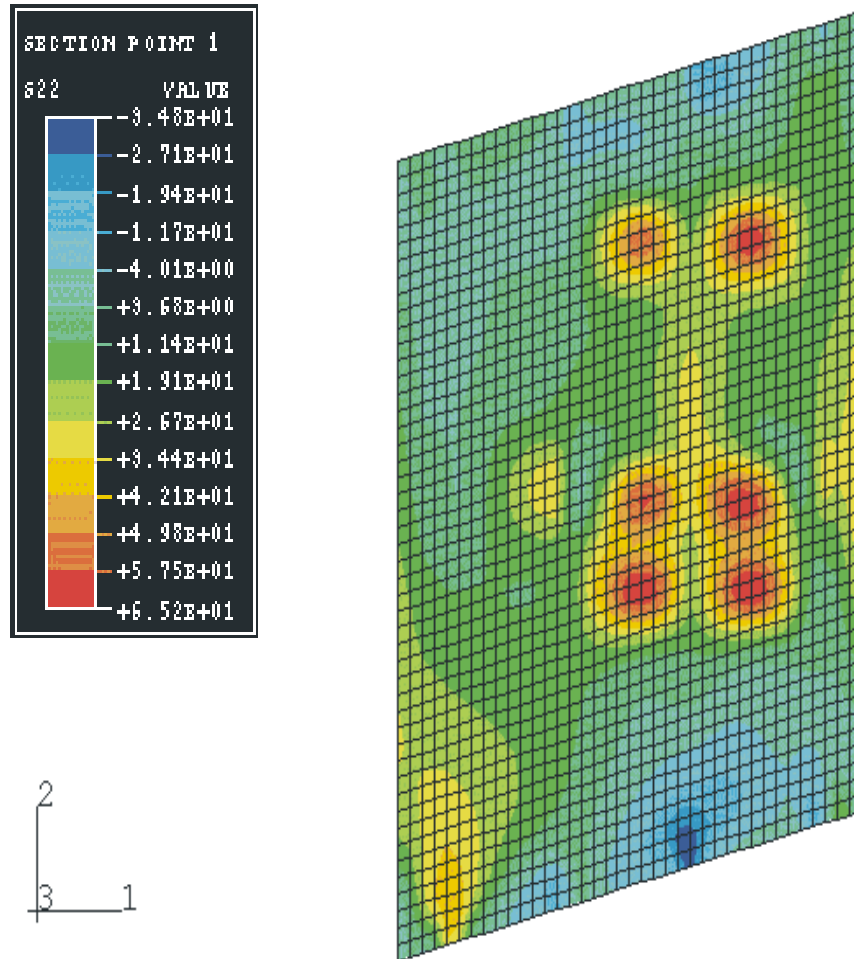


Figure 14. Transverse Stress Contours Along Bottom Surface of Deck



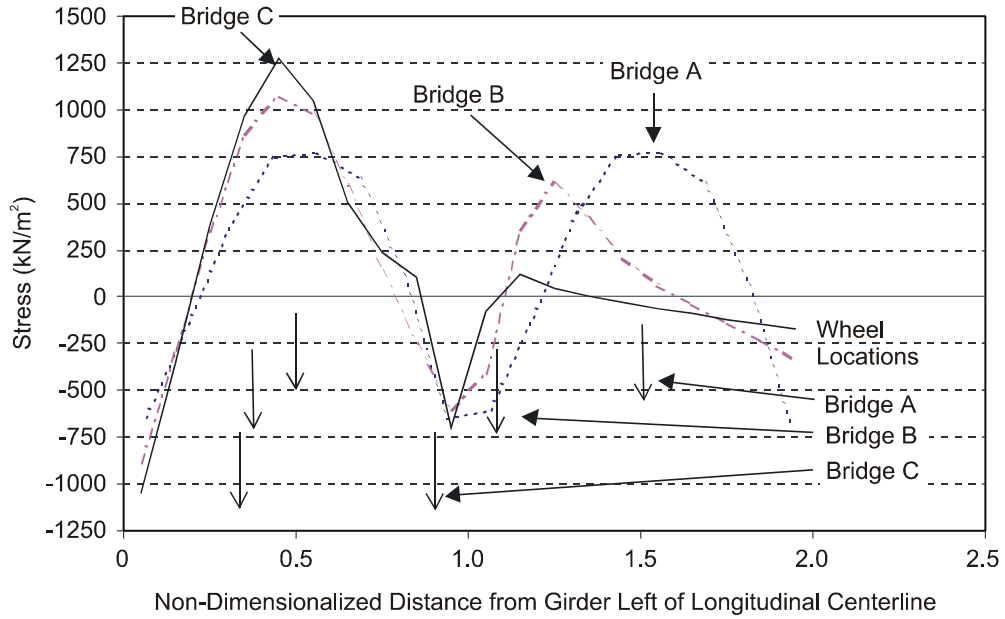
**Figure 15. Longitudinal Stress Contours Along Bottom of Deck**

of a girder-slab bridge such as the Willis River Bridge. Thus, the same procedure for model development should also be valid when applied to similar bridges having different dimensions.

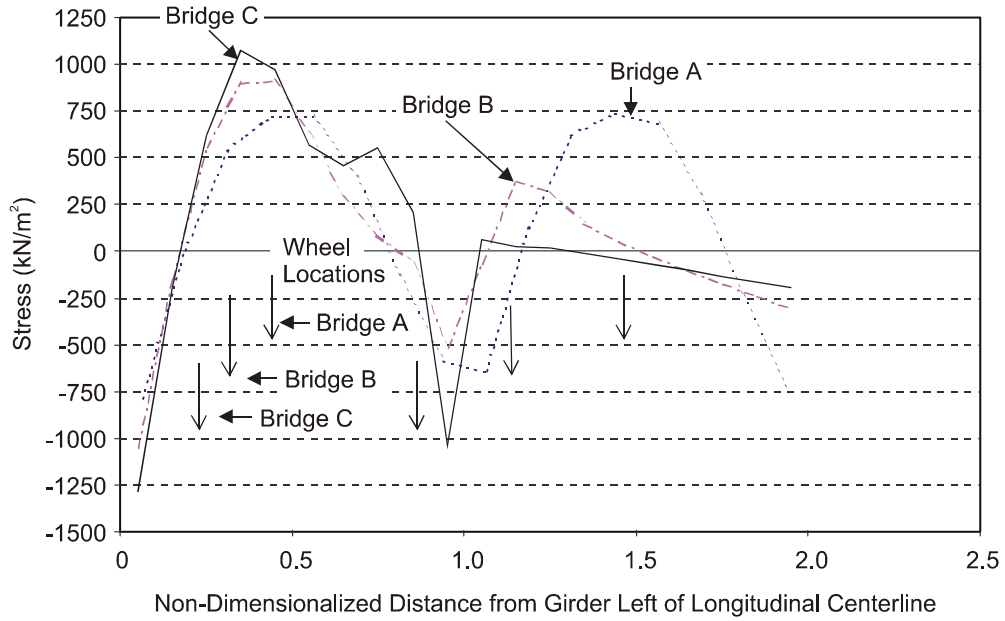
### **Effect of Girder Spacing on Response**

Data were collected from the elements between the girders that were loaded. For Bridge A, response data are reported between Girders 7 and 9; for Bridge B, data are reported between Girders 5 and 7; and for Bridge C, data are reported between Girders 4 and 6. Unless otherwise noted, all data are reported between these sets of girders. The  $x$ -axis of these plots represents the distance from the girder left of the longitudinal centerline nondimensionalized with respect to the girder spacing. This means that 0.0 on the  $x$ -axis represents the location of the left girder (for Bridge A, this is Girder 7), 1.0 on the axis represents the location of the middle girder (for Bridge A, this is Girder 8), and 2.0 on the axis represents the location of the right girder (for Bridge A, this is Girder 9).

Figures 16 and 17 plot deck stresses calculated for the three bridge models. Figure 16 is a plot of the maximum transverse tensile stress in the bottom surface of the deck as a function of transverse distance, and Figure 17 is a plot of the maximum transverse compressive stress versus



**Figure 16. Transverse Tensile Stress at the Bottom of the Deck for Bridges A, B, and C**



**Figure 17. Maximum Transverse Compressive Stress at Bottom of Deck for Bridges A, B, and C**

transverse distance. The maximum tensile stress in all three bridges, as shown in Figure 16, occurred at a distance of approximately 2.5 m (100 in) from the longitudinal midspan of each bridge. This distance corresponds to the location of the rear wheels of the truck. The data presented in this figure were taken from the line of elements that were 2.54 m (100 in) away from the midspan and between the girders in which the load was applied.

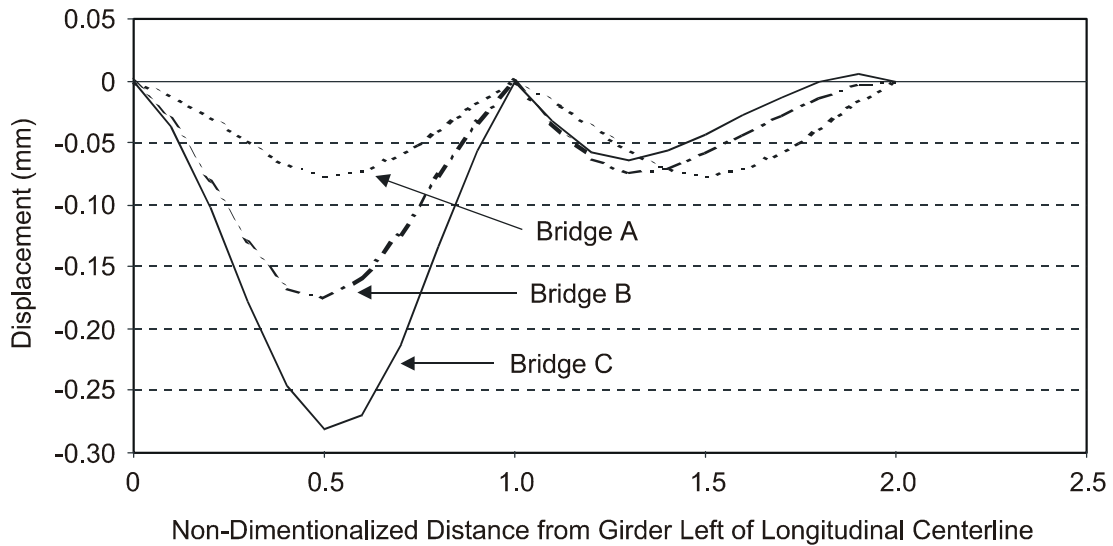
Figure 16 shows that the maximum transverse tensile stress that developed in the three bridges was  $1278.33 \text{ kN/m}^2$  (185.4 psi). This occurred in Bridge C approximately halfway between Girders 4 and 5. The maximum tensile stress in Bridge B was  $1073.55 \text{ kN/m}^2$  (155.7 psi) and occurred halfway between Girders 5 and 6. The maximum stress in Bridge A was  $776.38 \text{ kN/m}^2$  (112.6 psi) and occurred halfway between Girders 7 and 8.

Figure 17 shows the maximum transverse compressive stresses at the bottom of the deck plotted as a function of transverse distance along the deck. The maximum compressive stress in all three bridges occurred in the elements along the left girder at a distance of 1.65 m (65 in) from midspan. This location corresponds to the longitudinal location of the middle axle of the truck. The data presented in this figure were taken from the line of elements located 1.651 m (65 in) from the midspan of the bridges. The maximum compressive stress for the three bridges was found in Bridge C and had a magnitude of  $1290.1 \text{ kN/m}^2$  (187.1 psi). Bridge B had a maximum compressive stress of  $1053.6 \text{ kN/m}^2$  (152.8 psi), and Bridge A had a maximum compressive stress of  $791.5 \text{ kN/m}^2$  (114.8 psi).

From Figures 16 and 17, it can be observed that the stresses that developed between the left and middle girders were consistently greater for Bridge C than Bridge B and the stresses that developed for Bridge B were consistently higher than for Bridge A. The opposite trend occurred between the middle and right girders. The highest stress occurred in Bridge A, and the lowest stress was found in Bridge C. This was due to the location of the load. For Bridge A, the truck's right set of wheels was located midway between Girders 8 and 9, which produced the maximum stress in the deck. For Bridge C, both sets of wheels were to the left of the middle girder. Very little load was carried by the portion of the deck to the right of the middle girder (Girder 5).

Deck deflections are shown in Figure 18. The deflections plotted in this figure were determined by subtracting the appropriate girder deflection from the absolute deck deflection calculated from the model. Thus, Figure 18 shows the relative displacements of the bridge decks for Bridges A, B, and C, which were the displacements of just the deck. A linear interpolation was used to eliminate girder deflections. The maximum displacement of the deck for Bridge A in this figure is 0.076 mm (0.003 in), for Bridge B is 0.175 mm (0.007 in), and for Bridge C is 0.281 mm (0.011 in).

The response of the decks of the three bridges, as predicted from the computer models, clearly shows the effect of girder spacing on response quantities such as stress, strain, and deflection.



**Figure 18. Relative Deck Displacements**

## CONCLUSIONS

- The modeling techniques used in this study are valid.
- Commercial finite element codes such as ABAQUS can be used to model bridges with reinforced-concrete decks following the procedure outlined in this report.
- Other bridge geometries can be easily modeled through use of the modeling approach described in this study, thus allowing the evaluation of the effects of particular design parameters.
- Increasing girder spacing can significantly increase both tensile and compressive stresses in the deck.

## RECOMMENDATION

- VDOT should consider implementing advanced computational software for use in the analysis and design of bridge structures.

## SUGGESTIONS FOR FUTURE RESEARCH

To validate the analytical procedures described in this report further and to evaluate the effect of other design parameters using a similar procedure, future research efforts should include the following:

- Conduct additional field tests on bridges with different girder spacing and deck design parameters to confirm the analytical results predicted by the present study and by future studies.
- Evaluate the effect of reinforcement configuration on deck behavior, specifically the importance of top steel in deck response.
- Evaluate the effect of skew angle on deck behavior, with special attention given to the reaction forces developed in the plane of the deck and their interaction with abutments and piers.

## REFERENCES

- American Association of State Highway and Transportation Officials. (1994). *AASHTO LRFD Bridge Design Specifications* (U.S. Units, First Edition). Washington, DC: Author.
- Azizinamini, A. (1994). Old Concrete Slab Bridges: Analysis. *ASCE Journal of Structural Engineering*, Vol. 120, No. 11, pp. 3305-3319.
- Buckler, J.G. (2000). *Evaluation of Reinforced Concrete Bridge Decks*. Master's Thesis. University of Virginia, Charlottesville.
- Hibbitt, Karlsson, & Sorenson, Inc. (1998). *ABAQUS/Standard User's Manual: Version 5.8* (Vols. I-III). Pawtucket, RI: Author.
- Razaqpur, A.G. (1990). Analytical Modeling of Nonlinear Behavior of Composite Bridges. *Journal of Structural Engineering*, Vol. 116, pp. 1715-1733.
- Taavoni, S. (1990). *AISI Beam Design Program, Version 2.0*. Washington, DC: American Iron and Steel Institute.